



McIntosh Laboratory, Inc. 2 Chambers Street Binghamton, New York 13903-2699 Phone: 607-723-3512 www.mcintoshlabs.com



HOME &
PROFESSIONAL
AUDIOVISUAL

• MAPNH 8 AΘHNA 10433 • THΛ. 210 3845676 – 210 3845272 FAX. 210 3809747 • e-mail: sales@hifipower.gr •



Important Safety Information is supplied in a separate document "Important Additional Operation Information Guide"

Thank you from all of us at McIntosh

With the MA12000 Intergrated Amplifier, you have invested in a precision instrument that will provide you with many years of enjoyment. Please take a few moments to familiarize yourself with the features and instructions to get the maximum performance from your equipment.

If you need further technical assistance, please contact your dealer who may be more familiar with your particular setup including other brands. You can also contact McIntosh with additional questions or in the unlikely event of needing service.

McIntosh Laboratory, Inc.
2 Chambers Street
Binghamton, New York 13903

Technical Assistance: (607) 723-3512
Customer Service: (607) 723-3515
Fax: (607) 724-0549
Email: support@mcintoshlabs.com
Website: mcintoshlabs.com

Make a Note

For future reference, you can jot down your serial number and purchase information here. We can identify your purchase from this information if the occasion should arise.

Serial Number:	
Purchase Date:	
Dealer Name	

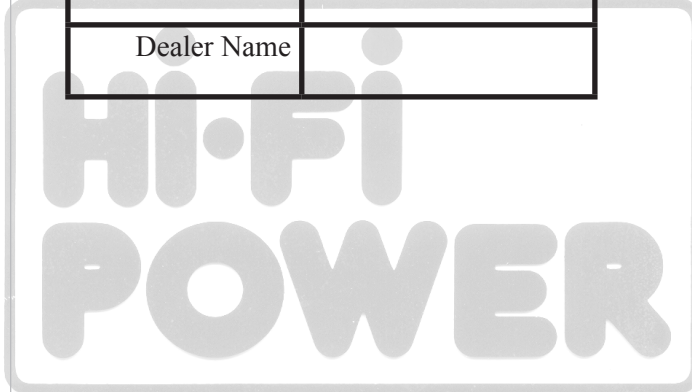
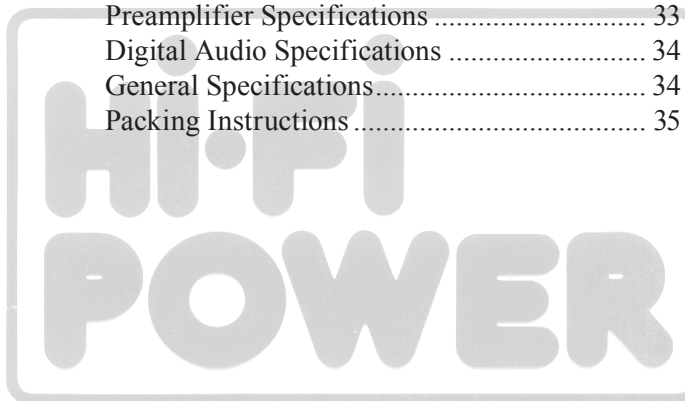

Table of Contents





Thank you from all of us at McIntosh	2
Make a Note	2
Trademark and License Information	3
General Information	4
Connector and Cable Information	4
Introduction	5
Performance Features	5
Dimensions	6
Installation	7
Rear Panel Connections	8
Making Connections	9
Phono/Unbalanced Inputs	9
Balanced/XLR Input and Output	9
RS232	9
Wired IR Input	9
Power Control (Trigger) Outputs	10
Passthru	10
Data Out	10
Headphones	11
HDMI (ARC) and CEC	11
Lip Sync Mode (ARC)	11
HDMI and Optical Gain	11
USB	12
Optical	12
Coax	12
MCT	12
Passthru Example	13
Connecting for Bi-Amplification	14
How to use the Remote Control	16
Remote Control Diagram	17
Trim Functions and Settings	18
How to Operate the Setup Mode	20
Default Settings	20
Firmware Version	20
Input Settings	20

Output Settings	22
Power Control Triggers 1 and 2	23
Data Ports	23
Passthru	24
Comm Port Baud Rate	24
Remote Control Codes	25
IR Sensor	25
Power Mode	25
Factory Reset	26
Reset of Microprocessors	26
How to Operate the MA12000	27
Preamplifier Specifications	33
Digital Audio Specifications	34
General Specifications	34
Packing Instructions	35



Trademark and License Information

The McIntosh MA12000 incorporates copyright protected technology that is protected by U.S. patents and other intellectual property rights. The MA12000 uses the following Technologies:

Trademark	License Information
	ASIO is a trademark and software of Steinberg Media Technologies GmbH
	Manufactured under license from Dolby Laboratories. Dolby, Dolby Audio, and the double-D symbol are trademarks of Dolby Laboratories.
	For DTS patents, see http://patents.dts.com . Manufactured under license from DTS, Inc. DTS, the Symbol, DTS and the Symbol together, and Digital Surround are registered trademarks and/or trademarks of DTS, Inc. in the United States and/or other countries. DTS, Inc. All Rights Reserved.
	The terms HDMI, HDMI High-Definition Multimedia Interface, and the HDMI Logo are trademarks or registered trademarks of HDMI Licensing Administrator, Inc.

General Information

1. For additional connection information, refer to the owner's manual(s) for any component(s) connected to the MA12000.
2. Apply AC Power to the MA12000 and other McIntosh Components only after all the system components are connected together. Failure to do so may cause a malfunction of system operations as the Microprocessor's Circuitry inside the components is active when AC Power is applied.
3. **The MA12000 includes a Power Mode Auto Off Feature and the default setting is enabled.** For additional information including how to disable it, refer to page 25.
4. When Power Amplifier Protection Circuitry of the MA12000 has activated, the LEDs under the Tubes illuminate the Tubes amber to alert you.
5. When the Power Transformer has overheated due to improper ventilation and/or high ambient operating temperature, AC Power is removed from the MA12000. Normal operation will resume when the operating temperature is in a safe range again.
6. For the best performance and safety, it is important to always match the impedance of the Loudspeaker to the Power Amplifier connections.
Note: The impedance of a Loudspeaker actually varies as the Loudspeaker reproduces different frequencies. As a result, the nominal impedance rating of the Loudspeaker (usually measured at a midrange frequency) might not always agree with the impedance of the Loudspeaker at low frequencies where the greatest amount of power is required. Contact the Loudspeaker Manufacturer for additional information about the actual impedance of the Loudspeaker before connecting it to the McIntosh MA12000.
7. The MA12000 Remote Control is capable of operating other components. For additional

information go to www.mcintoshlabs.com.

8. The IR Input, with a 1/8 inch mini phone jack, is configured for non-McIntosh IR sensors such as a Xantech Model DL85K Kit. Use a Connection Block such as a Xantech Model ZC21 when two or more IR sensors need to be connected to the MA12000. The signal from a connected External IR Sensor will have priority over the signal from the Front Panel IR Sensor.
9. When discarding the unit, comply with local rules or regulations. Batteries should never be thrown away or incinerated but disposed of in accordance with the local regulations concerning battery disposal.
10. For additional information on the MA12000 and other McIntosh Products please visit the McIntosh Web Site at www.mcintoshlabs.com.

Connector and Cable Information

XLR Connectors

Below is the Pin configuration for the XLR Balanced Connectors on the MA12000. Refer to the diagram for connection:

- PIN 1: Shield/Ground
- PIN 2: + Output
- PIN 3: - Output

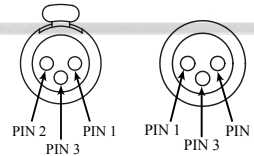

Power Control and Trigger Connectors

The Power Control Trigger Output Jacks send and Passthru Input Jack receives Power On/Off Signals (+12 volt/0 volt) when connected to other McIntosh Components. An additional connection is for controlling the illumination of the Power Output Meters on McIntosh Power Amplifiers. A 3.5mm stereo mini phone plug is used for connection to the Power Control, Trigger and

Main, Trig 1&2 and Pass-Thru

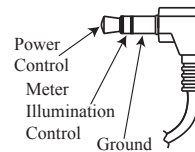

Passthru Outputs.

Data Port Connectors

The Data Out Ports send Remote Control Signals to Source Components. A 3.5mm stereo mini phone plug is used for connection.

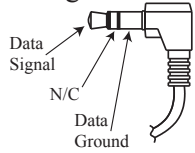

IR IN Port Connectors

The IR IN Port also uses a 3.5mm stereo mini phone plug and allows the connection of other brand IR Receivers to the MA12000.

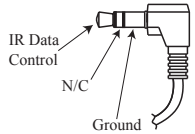

RS232-C Data Port Cable

The RS232 Data Cable is a 3.5mm stereo mini phone plug to a sub miniature DB 9 connector:

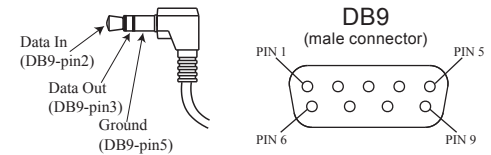

Binding Connector

When cables with spade lugs are used for Loudspeaker Connection, the spade lugs need an opening of at least 3/10 inch (7.6mm)

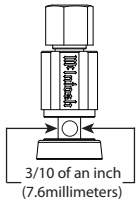

McIntosh Plug-In Jumper Connector

The MA12000 utilizes two phono style Plug-In Jumpers to connect the Preamplifier Output to the Power Amplifier Input.

Note: The Jumper Connector is available from the McIntosh Parts Department: McIntosh Jumper Connector Part No. 11808000

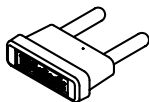

Introduction

Now you can take advantage of traditional McIntosh standards of excellence in the MA12000 Integrated Amplifier. The Power Amplifier section of the MA12000, with a power output of 350 watts per channel, will drive a pair of quality Loudspeakers to a high level of performance.

The flexible Preamplifier section features four AX7A Tubes and provides connections for various input sources and may also be used to drive an external Power Amplifier(s).

The MA12000 reproduction is sonically transparent and absolutely accurate. The McIntosh Sound is “The Sound of the Music Itself.”

Performance Features

• Power Output with Patented Autoformer

The MA12000 consists of a 350 watts per channel Power Amplifier with less than 0.005% distortion. The McIntosh designed and manufactured Autoformer allows connection of 2, 4 or 8 ohm Loudspeakers. The Power Amplifier uses ThermalTrak™¹ Output Transistors to minimize distortion and operating temperature.

• Sentry Monitor and Thermal Protection

McIntosh Sentry Monitor power output stage protection circuits ensure the MA12000 will have a long and trouble free operating life. Built-in Thermal Protection Circuits guard against overheating.

• Power Guard

The patented McIntosh Power Guard circuit prevents amplifier clipping and protects your valuable Loudspeakers. Tubes will glow amber when engaged.

• Electronic Switching and Balanced Connections

The Preamplifier uses Logic Controlled Electromagnetic Switches on all inputs and operating functions for reliable, noiseless, signal switching. There is a Balanced Input for connection of a source component.

• Digital Audio Inputs

The Digital Inputs decode PCM and DSD Signals from external sources. Coaxial, Optical and HDMI Inputs process Digital Signals up to 192kHz with 24-Bit resolution. The Digital MCT Input Circuitry directly decodes SACD/CD signals from an external Transport component. The USB Input Port can process streaming audio with 32-bit resolution up to 384kHz sampling rate. The Input Port can also process DSD512 as well as DXD 24-bit signals up to the same 384kHz sampling rate.

• Moving Coil and Moving Magnet Phono Inputs

The MA12000 has two precision Phono Preamplifier Circuits for Moving Coil and Moving Magnet Phono Cartridges. Both circuits use the latest designs to provide the lowest possible noise, distortion and flat frequency response. The MC and MM Phono Cartridge Inputs have selectable loading.

• Eight Band Equalizer

The Equalizer Controls provide ± 12 dB signal gain at center frequencies of 25, 50, 100, 200, 400, 1kHz, 2.5kHz and 10kHz. There is also an Equalizer Bypass Mode to remove the Equalizer from the Signal Path of any selected input.

• Multifunction Display and Power Meters

The Front Panel Display indicates source selection, volume levels and setup functions. The Illuminated Power Output Meters are peak responding, and indicate the power output of the amplifier.

• Power Control Output and Trigger Assignment

A Power Control connection for convenient Turn-On of McIntosh Power Amplifiers, Source Components and Accessories is included. The Power Control Trigger Outputs may be assigned to activate when a given Input/Output is selected.

• PassThru Mode

The Automatic PassThru Mode allows the MA12000 to become part of a Multichannel Sound System for DVD-Audio, SACD and Home Theater Movies.

• Remote Control

The Data Ports together with the supplied Remote Control provide control of McIntosh Source Components connected to the MA12000.

• Special Power Supply

The large Power Transformer, multiple filter capacitors with 280 Joules of Energy Storage and regulated Power Supply, ensures stable noise free operation even if the AC power line fluctuates.

• Solid Cinch™ Speaker Binding Posts

McIntosh Patented gold plated Binding Post deliver high current output. They securely accept large diameter wire and spade lugs. Banana plugs may also be used but only in the United States and Canada.

• Glass Front Panel and Super Mirror Chassis Finish

The famous McIntosh Illuminated Glass Front Panel uses long life Light Emitting Diodes (LEDs) and the Stainless Steel Chassis with Super Mirror Finish ensures that the MA12000 will retain its pristine beauty for many years.

¹ ThermalTrak™ and ON Semiconductor are trademarks of Semiconductor Components Industries, LLC

Dimensions

The following dimensions can assist in determining the best location for your MA12000. There is additional information on the next page pertaining to installing the MA12000 into cabinets.

Front View of the MA12000

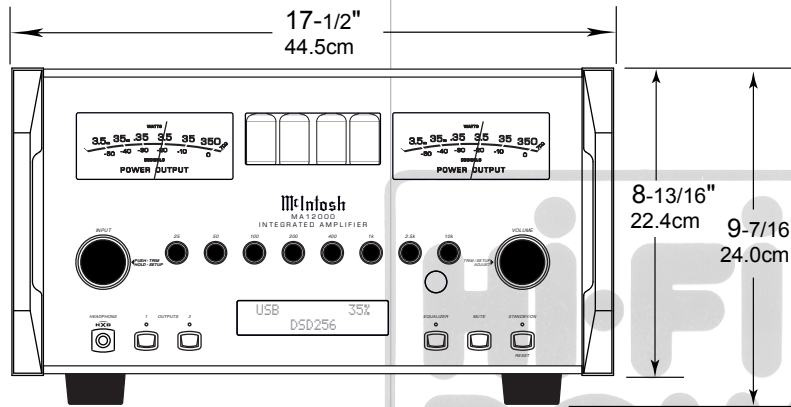

Rear View of the MA12000

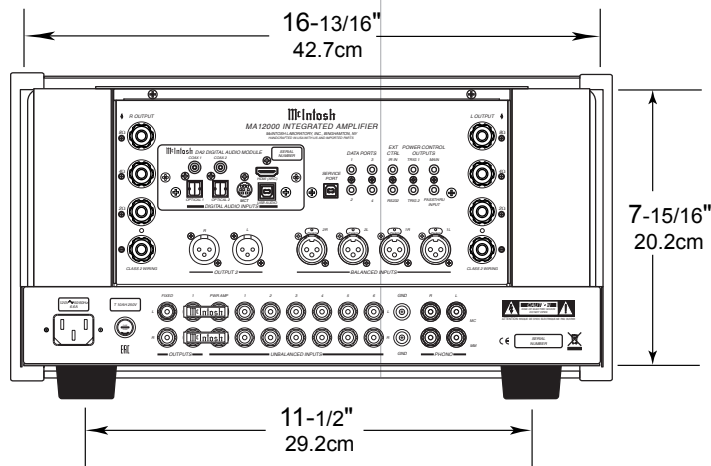

Side View of the MA12000

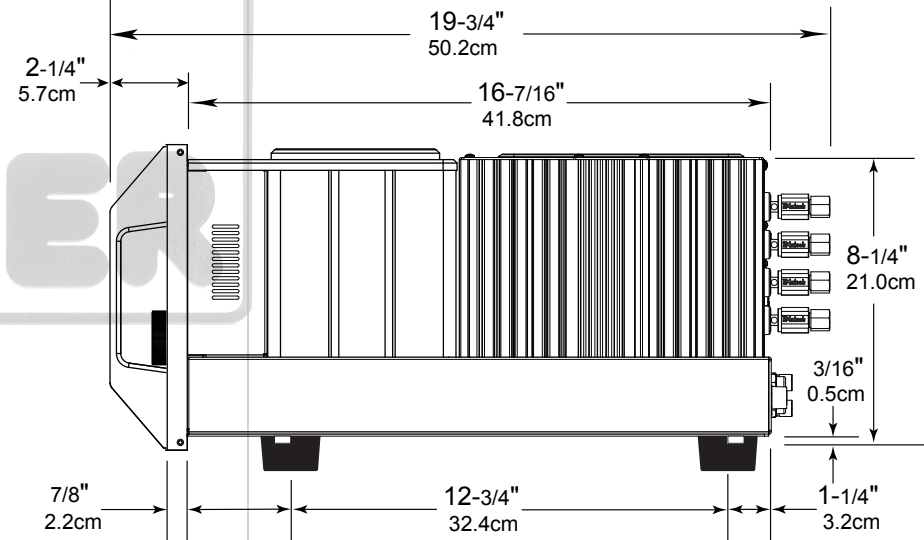

Installation

The MA12000 can be placed upright on a table or shelf, standing on its four feet. It also can be custom installed in a piece of furniture or cabinet of your choice. The four feet may be removed from the MA12000 when it is custom installed as outlined below. The four feet, together with the mounting screws, should be retained for possible future use if the MA12000 is removed from the custom installation and used free standing. The required panel cutout, ventilation cutout and unit dimensions are shown.

Always provide adequate ventilation for your MA12000. Cool operation ensures the longest possible operating life for any electronic instrument. Do not install the MA12000 directly above a heat generating component such as a high powered amplifier. If all the components are installed in a single cabinet, a quiet running ventilation fan can be a definite asset in maintaining all the system components at the coolest possible operating temperature.

A custom cabinet installation should provide the following minimum spacing dimensions for cool operation.

Allow at least 6 inches (15.24cm) above the top, 2 inches (5.08cm) below the bottom and 2 inches (5.1cm) on each side of the Integrated Amplifier, so that airflow is not obstructed. Allow 20 inches (50.8cm) depth behind the front panel. Allow 1-7/6 inch (3.66cm) in front of the mounting panel for knob clearance. Be sure to cut out a ventilation hole in the mounting shelf according to the dimensions in the drawing.

**MA12000 Front Panel
Custom Cabinet Cutout**

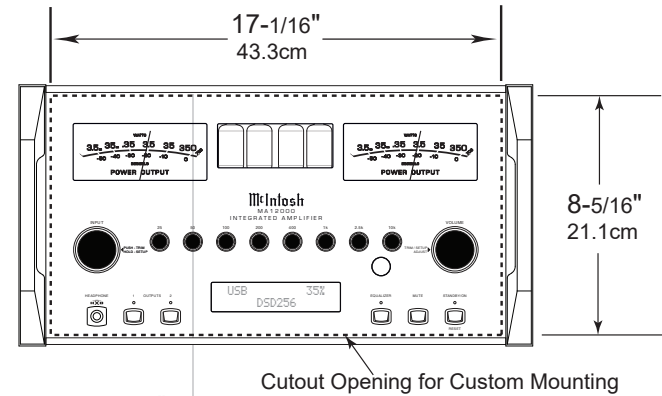

**MA12000 Side View
in Custom Cabinet**

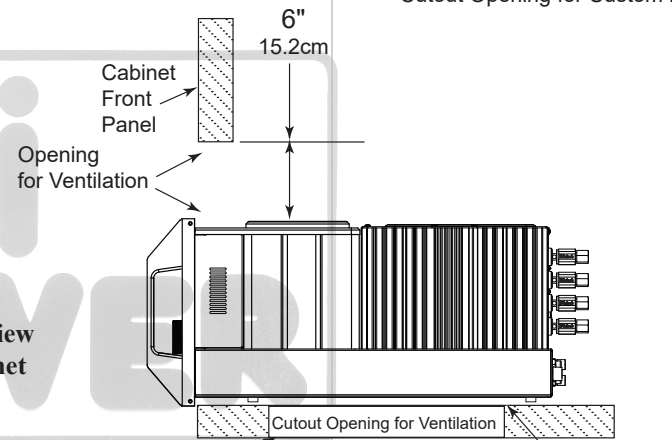

**MA12000 Bottom View
in Custom Cabinet**

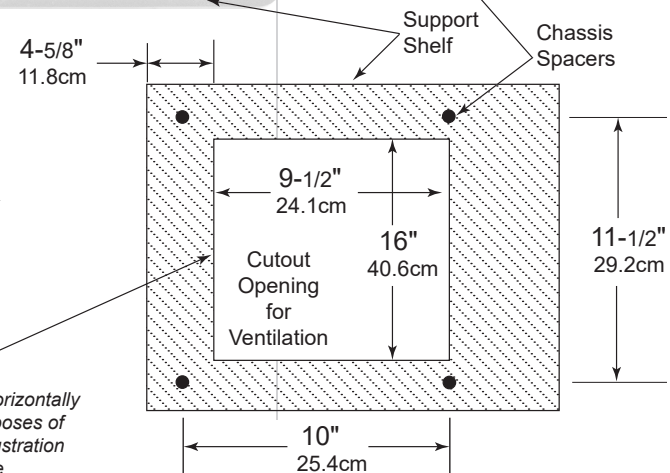

Note: Center the cutout horizontally on the unit. For purposes of clarity, the above illustration is not drawn to scale.



Rear Panel Connections

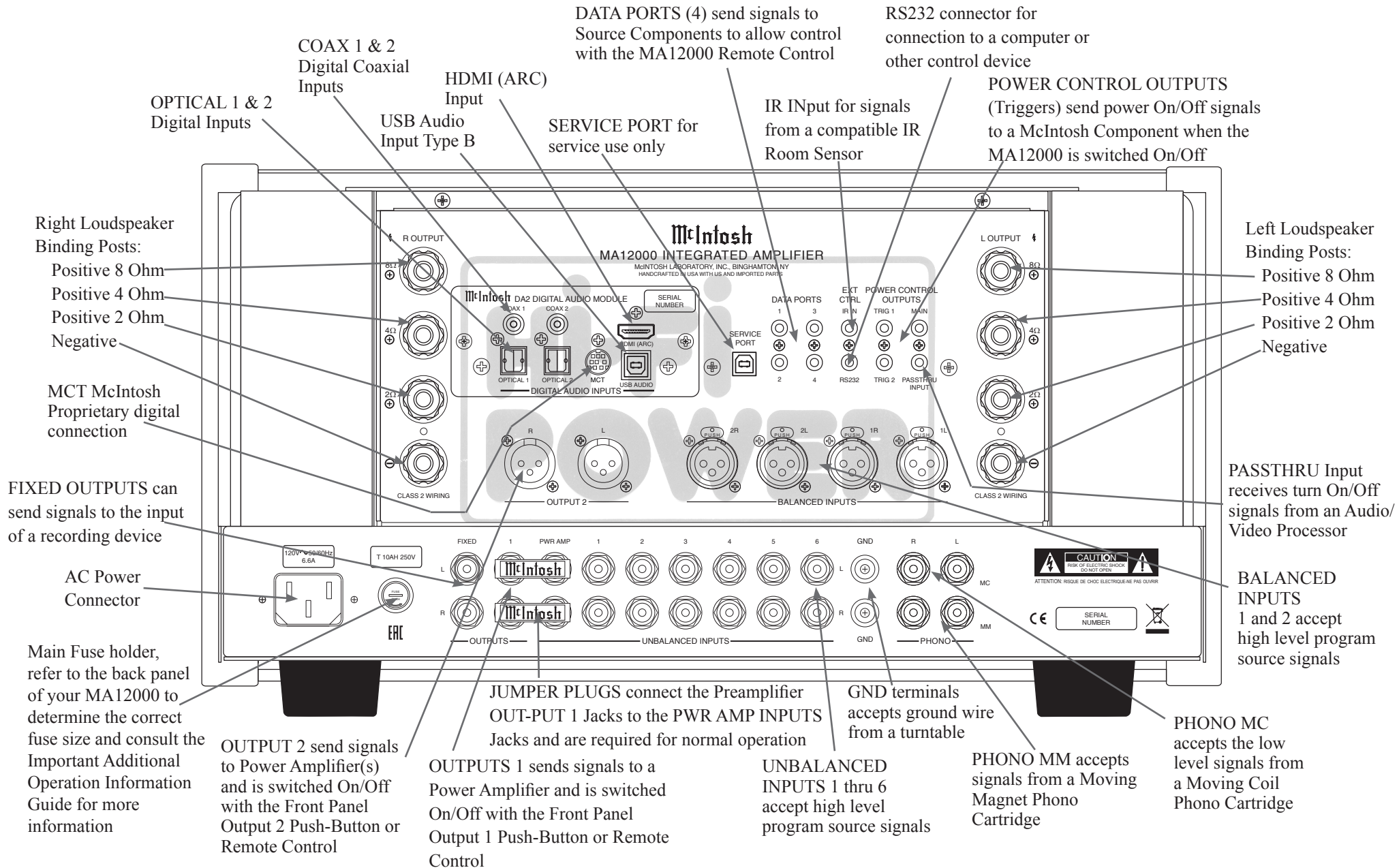

Making Connections

Phono/Unbalanced Inputs

Unbalanced Inputs such as the two PHONO INPUTS and UNBALANCED INPUTS 1 through 6 use RCA/phono cables (see Figure 01) to connect the MA12000 to other components. Traditionally, the red connector is used to connect the right channel. You are free to break tradition but keep the channels straight or left and right might be reversed.



Figure 01– RCA/Phono cables

The MA12000 can accept the analog input from a wide variety on components such as CD players, tuners, and turntables. There are two sets of unbalanced inputs dedicated for turntable connections which allow customization of the input level. See “Phono Adjustments” on page 28 . The signal strength from phono cartridges vary and are lower than the line level received from most other components. The turntable will also have a ground connection which should be secured to the MA12000’s GND Binding Post to eliminate ground hum. Turn the Binding Post counterclockwise to loosen and attach the ground wire. Turn the Binding Post clockwise to secure the ground connection. The MC PHONO INPUT should be used for low

output Moving Coil Cartridges. The MM PHONO INPUT should be used for Moving Magnet and high output Moving Coil Cartridges.

Balanced/XLR Input and Output

The BALANCED INPUT allows a source to be connected using XLR (balanced) cables if the source has this option.

XLR cables can also be used to connect the MA12000 to an external amplifier. OUTPUT 2 has a pair of XLR connectors labeled R for Right and L for Left. To use the XLR output, connect the OUTPUT 2 R jack to the right input of your amplifier and OUTPUT 2 L jack to the amplifier’s left input.

Below is the Pin configuration for the XLR Balanced Input and Output Connectors on the MA12000. Refer to the diagrams for connections:

- PIN 1: Shield/Ground
- PIN 2: + Signal
- PIN 3: - Signal

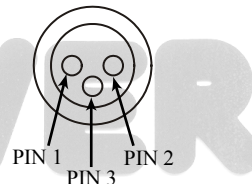

Figure 02– XLR pin diagram

RS232

The RS232 jack is used to connect the MA12000 to automation controller devices with RS232 connectors. To utilize this feature, you will need an appropriate RS232 Data Cable. The RS232 Data Cable should be an 1/8 inch (3.5mm) stereo mini phone plug to a subminiature DB9 connector.

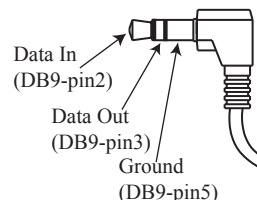

Figure 03– Mini plug for RS232 connection

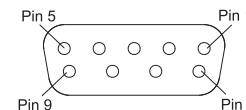

Figure 04– DB9 connector pin layout

RS232 DB9 Connector Pin Layout

- | | |
|------------------------|--------|
| 1. N/C (no connection) | 6. N/C |
| 2. Data In (RXD) | 7. N/C |
| 3. Data Out (TXD) | 8. N/C |
| 4. N/C | 9. N/C |
| 5. Gnd | |

Typical RS232 settings are:

- 8 data bits, no parity and one stop bit
 - Baud rate fixed at 115,200 bits per second
- The baud rate can be changed in the Setup. See “Comm Port Baud Rate” on page 24.

Wired IR Input

The IR Input allows an external IR receiver to be attached to the MA12000. The Input is labeled IR IN. By attaching an IR receiver using a 3.5mm cable (Figure 09), the MA12000’s Remote Control can be used in another location without a line-of-sight to the MA12000’s front IR sensor.

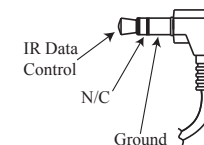

Figure 05– IR 3.5mm connector

If using an external IR receiver for the MAIN ZONE in the same room as the MA12000, you may wish to **disable the front IR sensor**. This will avoid potential timing issues of receiving the Remote Control’s commands from two different Inputs. The

front IR can be turned on/off by doing the following:

- Press and Hold the Left Knob for two seconds
- Turn the Left Knob to the menu choice “SETUP: Front IR”
- Turn the Right Knob clockwise for Enabled (on) or counterclockwise (off)
- Press and release the Left Knob to exit the Setup menu

AC Power

This connection is essential. Plug the female end of the supplied AC Power Cord into the AC connector (standard 15 ampere IEC) located in the rear right corner of the MA12000. Plug the male end of the AC Power Cord into a grounded and functioning AC outlet.

Power Control (Trigger) Outputs

The MA12000 has three Power Control Outputs or Triggers:

- MAIN
- TRIG 1
- TRIG 2

Power Control enables power on/off signals to go to connected components so that other components can automatically power on (or off) as called for by the MA12000.

Connect components to the Triggers using a 3.5mm stereo mini plug. See Figure 06. The Triggers work by sending on/off signals in the form of +12 volt/0 volt to connected McIntosh components. See “Power Control Triggers 1 and 2” on page 23.

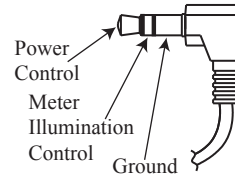

Figure 06– Power control (trigger) mini plug

Passthru

The MA12000’s PASSTHRU feature allows your 2-channel system to be incorporated into a multichannel system, typically as the left and right front speakers. When the connected unit (Master) powers on, it will take control of your MA12000. The MA12000 will send the signal to your amplifier and speakers at a volume controlled by the Master. The MA12000 preamplifier is now a slave to the source unit and you cannot control the sound from this unit until the source unit is shutoff or disconnected.

To use the PASSTHRU feature, connect the controlling unit to the MA12000’s PASSTHRU connector using the same type of cable as used for Power Control (Trigger) Outputs. The MA12000 PASSTHRU jack should be connected to a Power Control Trigger Output of the controlling unit.

To enable (or disable) PASSTHRU, enter Setup. When enabled, an Input must be assigned to PASSTHRU. When in PASSTHRU mode, the MA12000 will send the signal from the assigned Input to the MA12000’s Outputs. The volume will be dictated by the controlling unit.

To turn off or assign an Input for PASSTHRU:

- Press and Hold the Left Knob for two seconds
- Turn the Left Knob to the menu choice “SETUP: PASSTHRU”
- Turn the Right Knob to scroll through the

following options:

- Off
- Balanced
- Unbal 1
- Unbal 2

(Note: if you have changed an Input’s name, the new name will appear.)

- Press and release the Left Knob to exit Setup. Your choice will be saved

When in PASSTHRU mode, control of the MA12000 is limited to the Trim functions: DISPLAY BRIGHTNESS and AMP METER LIGHT. To regain controls, the Controlling unit must be shut (or Power Control cable removed from the PASSTHRU connector.)

For an example Passthru diagram, see “Passthru Example” on page 13.

Data Out

The MA12000 will convert IR Remote Control data to share with McIntosh components connected to the DATA PORTS. This will allow units that are out of range of an IR signal to receive commands. A McIntosh source can thereby be controlled by the MA12000 Remote.

There are four DATA PORTS labeled 1 through 4. To connect a McIntosh unit to a Data Port, use a 3.5mm stereo mini phone plug cable, see Figure 07.

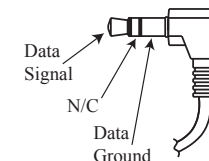

Figure 07– Data Port mini plug

Headphones

The MA12000 features High Drive Headphone Amplification. The output of the High Drive Headphone Amplification provides plenty of power with the flexibility to utilize a wide range of headphones types including high impedance headphones.

Connect your headphones using a stereo ¼ inch plug to the HEADPHONES jack on the right of the INPUT Knob. The initial volume of the headphones will be the last volume used for headphones with a startup limit of 70. When headphones are connected, the other outputs will be muted unless this default setting is changed in Setup.

The MA12000 Headphone Crossfeed Director Circuitry (HXD®) improves the sound localization for Headphone Listening. HXD restores the directionality component of the spatial sound stage normally heard with Loudspeaker listening. HXD can be enabled or disabled in Trim functions when headphones are plugged in. The default is for the HXD circuit to be on. To change the HXD setting:

- With headphones attached, press and release the Left Knob (INPUT) to enter Trim
- Turn Left Knob to the “HEADPHONE HXD” screen
- Turn the Right Knob (VOLUME) to choose On or Off
- Press and release the Left Knob to exit (Trim screen will time-out and exit after around 10 seconds of no input)

HDMI (ARC) and CEC

The MA12000 HDMI Input Connector has (ARC) Audio Return Channel Circuitry, allowing the Audio Selection and Control Command of HDMI TV/ Monitor Devices. To function properly, make sure this feature is enabled in your TV’s setup menu.

To Activate or deactivate the Consumer Electronics Control (CEC) functions of Volume or Power control of the HDMI Devices connected to the HDMI input, perform the following steps:

- Press and hold the Left Knob (INPUT) for two seconds to enter Setup
- Rotate the Left Knob to the “SETUP: HDMI CEC VOL” screen or the “SETUP: HDMI CEC PWR” screen
- Turn the Right Knob (VOLUME) to choose On or Off
- Press and release the Left Knob to exit

Lip Sync Mode (ARC)

The MA12000 HDMI Input Connector (ARC) Audio Return Channel Circuitry, also has another control function. When listening and viewing a TV/ Monitor HDMI Input Signal, the ARC circuitry provides a synchronized Video and Audio TV/ Monitor Signal automatically.

To toggle the AUTO Synchronised Video and AudioTV/Monitor Signal (or Lip Sync Mode) from Auto to Manual, perform the following steps:

- Press and hold the Left Knob (INPUT) for two seconds to enter Setup
- Rotate the Left Knob to the “SETUP: Lip Sync Mode” screen
- Turn the Right Knob (VOLUME) to choose Auto or Manual

- Press and release the Left Knob to exit

When Lip Sync Mode is set to Manual, an additional Trim option will be available “HDMI LIP SYNC DELAY” This allows an audio delay of between 0ms and 150ms to be manually set in 10ms increments. To set delay:

- Press and release the Left Knob (INPUT) to enter Trim
- Turn Left Knob to the “HDMI LIP SYNC DELAY” screen
- Turn the Right Knob (VOLUME) adjust the delay value from 0ms to 150ms
- Press and release the Left Knob to exit (Trim screen will time-out and exit after around 10 seconds of no input)

HDMI and Optical Gain

Many video sources such as broadcast video to television sets have sound levels that are lower than typical music sources. Because of this, a volume boost has been added to the HDMI input making it louder. The ability to adjust the volume boost of the Optical input has been added so that the Optical input could be boosted as needed.

- Press and hold the Left Knob (INPUT) for two seconds to enter Setup
- Rotate the Left Knob to the “SETUP: Digital Gain” screen
- Press and hold the Left Knob for two seconds
- Turn the Left Knob to choose the Input (HDMI, OPTI 1 or OPTI 2) to adjust
- Turn the Right Knob (VOLUME) to adjust the Gain from 0dB to 15dB in 1dB increments
- Press and release the Left Knob to exit the menu

USB

The USB input of the MA12000 provides the capability to play music from a connected computer.

Software Requirements

Apple® Macintosh® computers require OS-10.6.8 or later. Apple computers require no additional driver install to communicate with the MA12000.

For Windows-based computers (PC), Windows 7 (SP1) or later is required. The correct McIntosh USB Audio driver must be installed for the PC to communicate with the MA12000.

To **install the McIntosh USB Driver** for Windows-based computers:

Download the latest driver from the McIntosh website: <https://www.mcintoshlabs.com/products/integrated-amplifiers/MA12000>

The driver can be found in the Downloads section of the webpage under Software Updates. Choose the DA2 Digital Audio Module: McIntosh USB Audio Windows Driver

- Unzip the McIntosh_UsbAudio file
- Run the File
- Choose “Yes” to allow changes to your computer (see Figure 08)
- Follow software prompts selecting “Next” or “Install” as needed
- Click “Finish” when driver is installed

Next, connect the Computer to the MA12000 using a **USB 2.0** Cable Type A to Type B (see Figure 09)

Windows should detect the new device (if you installed the driver software as directed above) and install the driver as indicated by a message in the lower part of your monitor.

You can use the Windows Control Panel to select the new audio device which will appear as “McIntosh HD-HS2 USB Audio”. You may also select this

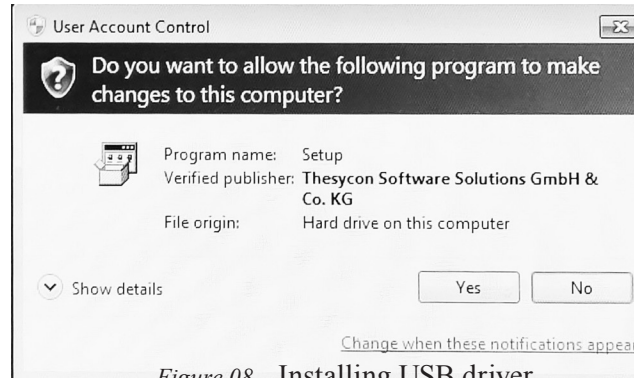

Figure 08– Installing USB driver software



Figure 09– USB Cable

driver in many third-party applications such as JRiver Media Center.

The MA12000’s display will show the sampling rate or bit rate for the USB input.

Optical

The two Optical Inputs allow digital sources to be connected to the MA12000 using TOSLINK cables also known as “optical audio cables.” The Optical Inputs can handle high resolution digital audio up to 192kHz/24-bit. The MA12000 DAC will process standard format SPDIF PCM signals as well as

Dolby Digital and DTS encoded multi-channel bit streams. Unsupported formats can result in strange and/or unpleasant sounds.

Coax

The two Digital Coax (Coaxial) Inputs allow digital sources to be connected to the MA12000 using Digital Audio RCA Coaxial Cables. The Coax Inputs can handle high resolution digital audio up to 192kHz/24-bit. The MA12000 DAC will process standard format SPDIF PCM signals as well as Dolby Digital and DTS encoded multi-channel bit streams. Remember, unsupported formats can result in strange and/or unpleasant sounds.

MCT

The Digital MCT Input Circuitry of the MA12000 directly decodes SACD/CD signals (as well as PCM) from an external Transport component. With MCT, a secure digital connection is created, allowing for the playback of the high definition audio found on SACDs. Regular CDs can also be played over the MCT connection. Use an MCT cable to connect the MCT din jacks from the source to the MA12000. The Digital MCT Cable is a McIntosh custom designed cable and is included with McIntosh Transports. The MCT cable is part number 171923 and can be ordered from the McIntosh Parts Department.

Passthru Example

The MA12000 can be part of a Multichannel Sound System for BLU-RAY Audio, DVD Audio and Home Theater Movies. The Right and Left Front Channels from an Audio/Video Control Center can “Passthru” the MA12000. In the following example the UNBALANCED 6 Input will become the “Passthru” input:

1. Connect Audio Cables from the A/V Processor FL (Front Left) and FR (Front Right) Channel Outputs to the MA12000 UNBALANCED 6 INPUTS Left and Right Jacks.
2. Connect a Control Cable from the A/V Processor TRIGGER 2 Output to the MA12000 POWER CONTROL PASSTHRU INPUT Jack.

See “Passthru” on page 10 for more information..

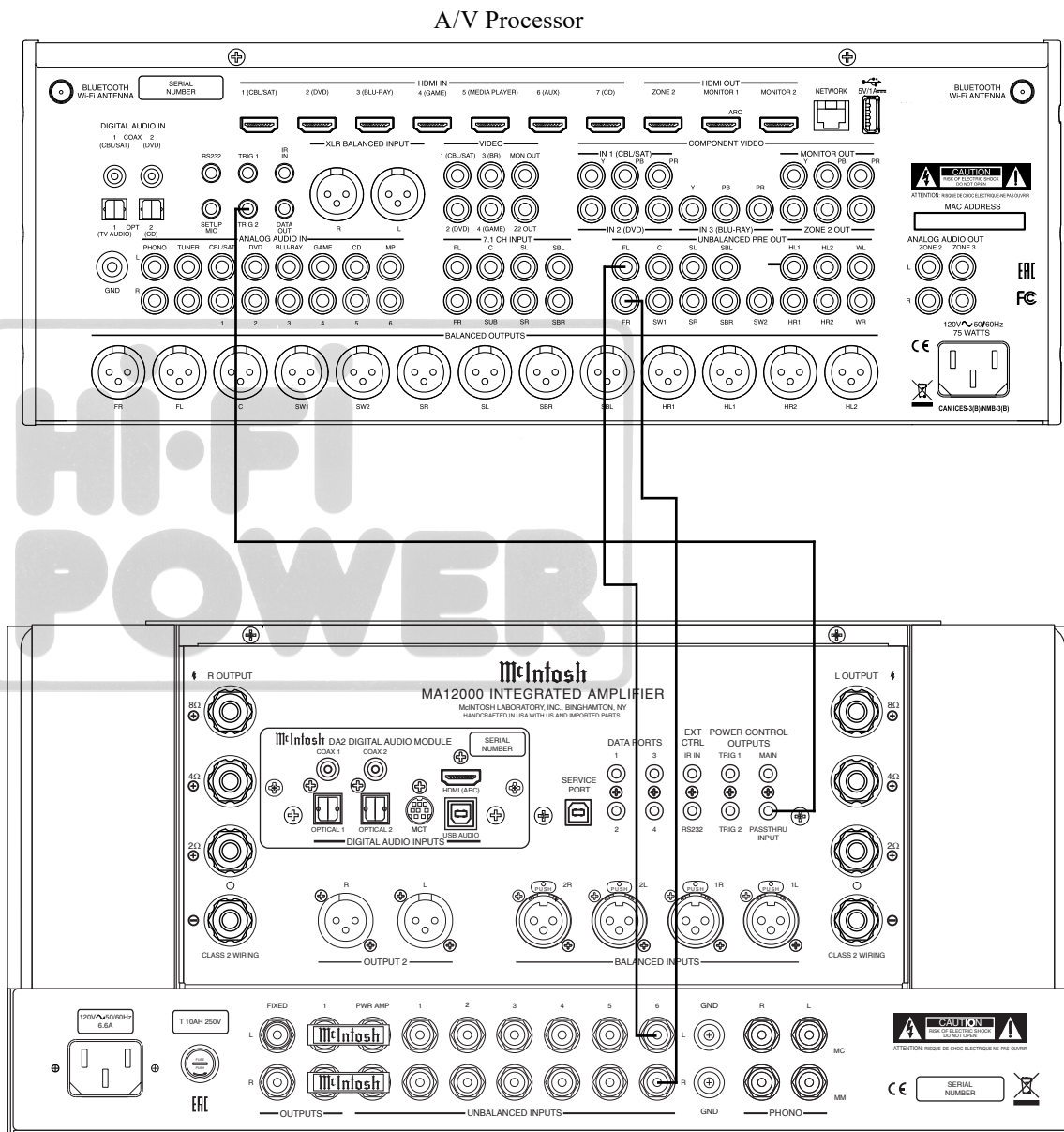

Connecting for Bi-Amplification

The MA12000 Power Amplifier Circuitry, together with an additional separate Power Amplifier, may be used to Bi-Amplify a Loudspeaker System. In the illustration on this page, the Power Amplifier of the MA12000 is connected to the Midrange/High Frequency Section of the Loudspeaker. The additional separate Power Amplifier is connected to the Low Frequency Section of the Loudspeaker System.

Warning: *The Loudspeaker System used for Bi-Amplification must have the jumpers removed from between the MID/HIGH and LOW Frequency Sections of the Loudspeaker System. Failure to remove them could result in damage to the MA12000 and/or the separate Power Amplifier.*

MA12000 Connections:

1. Remove the “McIntosh Jumpers” from between the OUTPUT 1 Jacks and the PWR AMP In Jacks located on the Rear Panel of the MA12000.

Note: Place the “McIntosh Jumper” in a safe place for possible future use.

2. Using a pair of shielded RCA Type Audio “Y” Adapters connect the OUTPUT 1 Jacks to the PWR AMP In Jacks, for both Left and Right Channels.
3. Connect the remaining unconnected part of the “Y” Adapters to the separate Power Amplifier.
4. Referring to “How to Connect Loudspeakers” on page 15, and the owner’s manuals for your Power Amplifier and Loudspeaker, connect the MA12000 Binding Post to the Loudspeaker MID/HIGH Input Terminals.

Note: The Loudspeaker Connection illustrations on this page are for the Left Channel. Connect the Right Channel Loudspeaker in the same manner.

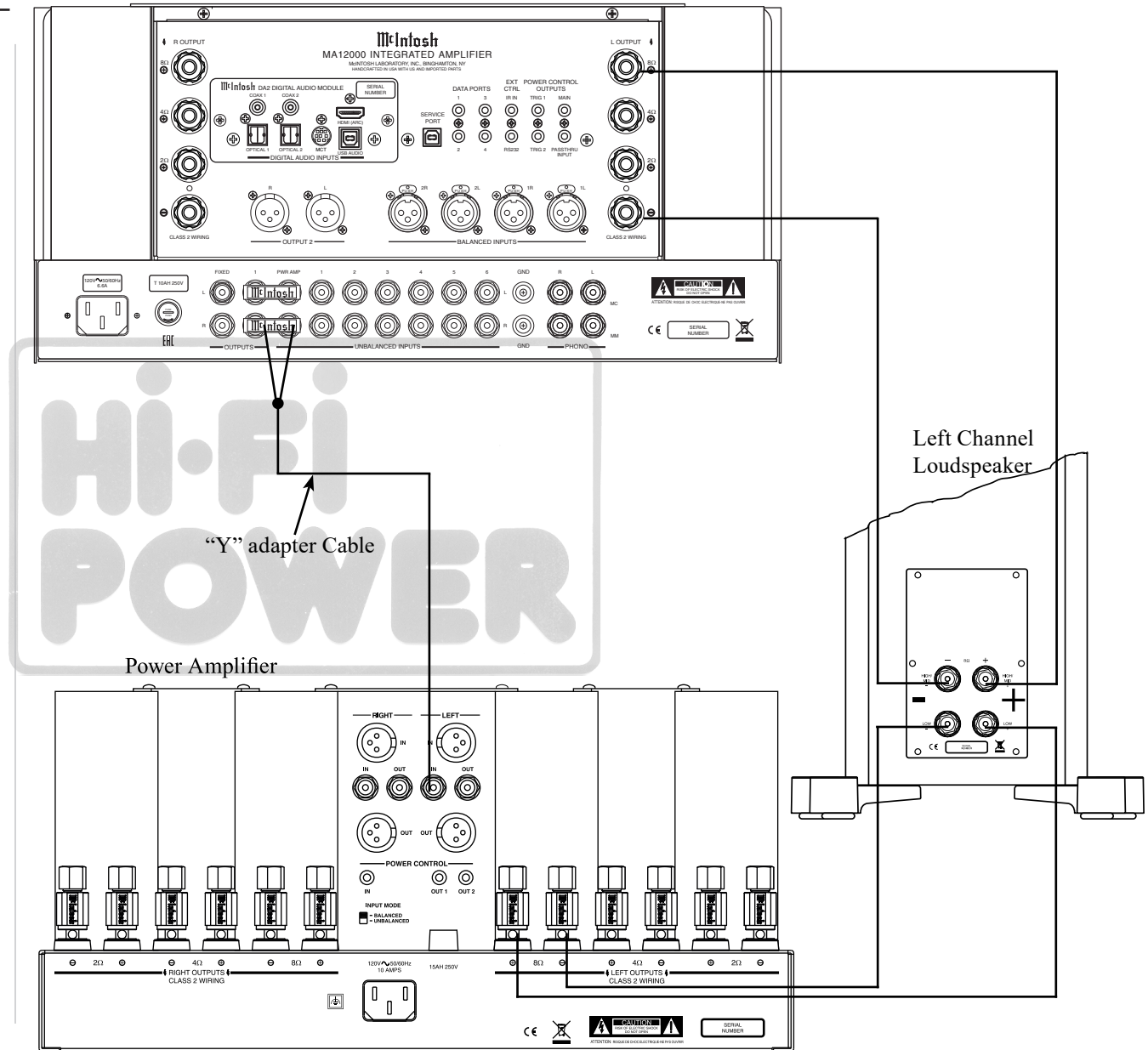

Solid Cinch™ Speaker Binding Posts

When connecting the Loudspeaker Hookup Cables to the MA12000 Amplifier Binding Posts please follow the steps below:

1. Rotate the top of the Binding Post counterclockwise until an opening appears. Refer to figures A and B.
2. Insert the Loudspeaker hookup cable into the Binding Post opening or the cable spade lug around the center post. Refer to figure C.
3. Rotate the top of the Binding Post clockwise until it is finger tight. Refer to figure D.
4. Place the supplied McIntosh Wrench over the top of the Binding Post and rotate it one quarter of a turn (90°) to secure the Loudspeaker Cable Connection. **Do not over tighten.** Refer to figure E.

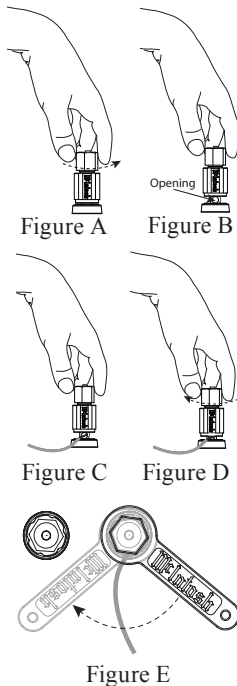

How to Connect Loudspeakers

Caution: Do not connect the AC Power Cord to the MA12000 Rear Panel until after the Loudspeaker Connections are made. Failure to observe this could result in Electric Shock.

The McIntosh MA12000 Power Amplifier Circuitry is designed for Loudspeakers with an impedance of 2 ohms, 4 ohms or 8 ohms. Connect a single Loudspeaker only to the Right and Left Binding Post. When connecting Loudspeakers to the MA12000 it is very important to use cables of adequate size, to minimize power loss in the cables. The size is

specified in Gauge Numbers or AWG (American Wire Gauge). The smaller the Gauge number, the larger the wire size:

Loudspeaker Cable Distance vs Wire Gauge Guide			
Loudspeaker Impedance	25 feet (7.62 meters) or less	50 feet (15.24 meters) or less	100 feet (30.48 meters) or less
2 Ohms	12AWG	10AWG	8AWG
4 Ohms	14AWG	12AWG	10AWG
8 Ohms	16AWG	14AWG	12AWG

1. Prepare the Loudspeaker Hookup Cable for attachment to the MA12000 Power Amplifier Circuitry:

Bare wire cable ends:

Carefully remove sufficient insulation from the cable ends, refer to figures F, G & H. If the cable is stranded, carefully twist the strands together as tightly as possible.

- Notes:
1. If desired, the twisted ends can be tinned with solder to keep the strands together.
 2. The prepared bare wire cable ends may be inserted into spade lug connectors.
 3. Banana plugs are for use in the United States and Canada only.

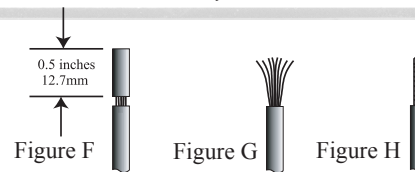

Banana Plugs are for use in the United States and Canada only:

2. Attach the previously prepared bare wire cable ends into the banana plugs and secure the connections. Refer to figure I.
3. Rotate the Binding Post clockwise until it is finger tight. Refer to

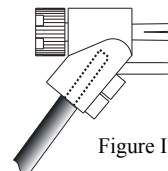

figure J. Then using the McIntosh Wrench, rotate the top of the Binding Post one quarter of a turn (90°). **Do not over tighten.** Refer to figure E.

4. Referring to figure K, connect the Loudspeaker hookup cables with banana plugs into the hole at the top of the terminal

Negative Binding Post and Positive Binding Post identified as 2Ω (ohms), 4Ω (ohms) or 8Ω (ohms) connection to match the impedance of the Loudspeaker, being careful to observe the correct polarities.

If the Loudspeaker's impedance is in-between the available connections, use the nearest lower impedance connection. Refer to "General Information" Note 6 on page 4 for additional information.

WARNING: Loudspeaker terminals are hazardous live and present a risk of electric shock. For additional instruction on making Loudspeaker Connections contact your McIntosh Dealer or McIntosh Technical Support.

5. Connect the MA12000 power cord to an active AC outlet.

Spade Lug or Wire Connections:

6. Connect the Loudspeaker hookup cables to the MA12000 Negative Binding and Positive Binding identified as 2Ω (ohms), 4Ω (ohms) or 8Ω (ohms) connection to match the impedance of the Loudspeaker, being careful to observe the correct polarities. Insert the spade lug connector or

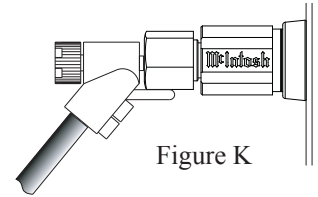
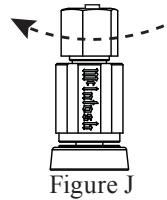

prepared section of the cable end into the terminal side access hole, and tighten the terminal cap until the cable is firmly clamped into the Binding Post so the lugs or wire cannot slip out. Refer to figures L and M.

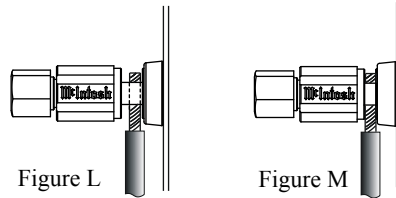

If the Loudspeaker's impedance is in-between the available connections, use the nearest lower impedance connection.

Note: The impedance of a Loudspeaker actually varies as the Loudspeaker reproduces different frequencies. As a result, the nominal impedance rating of the Loudspeaker (usually measured at a midrange frequency) might not always agree with the impedance of the Loudspeaker at low frequencies where the greatest amount of power is required. Contact the Loudspeaker Manufacturer for additional information about the actual impedance of the Loudspeaker before connecting it to the McIntosh MA12000.

WARNING: Loudspeaker terminals are hazardous live and present a risk of electric shock. For additional instruction on making Loudspeaker Connections contact your McIntosh Dealer or McIntosh Technical Support.

7. Connect the MA12000 power cord to an active AC outlet.

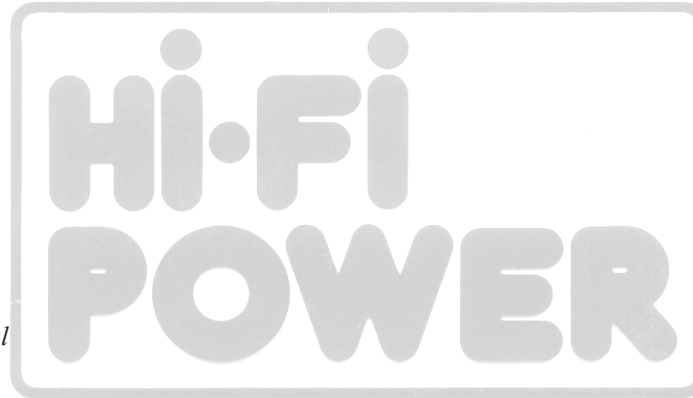

How to use the Remote Control

The supplied MA12000 Remote Control (HR085) is capable of directly controlling the functions of contemporary McIntosh Source Components connected to the MA12000 via the Data Ports.

- Notes:*
1. If at any time the MA12000 seems unresponsive to the HR085 Remote Control Commands, press the DEVICE Push-button to select **McIntosh** first.
 2. For additional information on using the HR085 Remote Control with the McIntosh Model, please refer to the "How to Operate" starting on page 27.
 3. For additional information on assigning the Data Ports, refer to "Data Ports" on page 23.

Trim

Press the TRIM Push-button until the desired Trim function (Balance, Trim Level, etc.) appears on the MA12000 Front Panel Display, then press the LEVEL Up or Down Push-button to adjust the Trim setting.

Note: Press the TRIM Push-button to recall the last Trim function selected.

Output Selection

Press the BLUE (Setup) Push-button followed by the AM (Output 1) or FM (Output 2) Push-button, to control the Rear Panel Audio OUTPUTS 1, 2 (ON or OFF) and Power Control TRIG 1 / TRIG 2.

Note: For additional information on assigning the Outputs (1 and 2) and Power Control Triggers (1 and 2) refer to pages 22 and 23.

Remote Control Diagram

LEDs illuminate when sending a remote command and when programming the remote control

Select the DEVICE to select the target for the remote control's commands

SETUP Push-button is used as a "Shift Key" to select a function with blue color nomenclature

Selects AM Tuner Operating Functions, select Output 1 when used with the SETUP/shift Push-button and Track Selection on certain McIntosh CD Players

Press the Trim Push-button and then the LEVEL UP Push-button to select and adjust various functions. MENU is used with McIntosh Models displaying choices on a video screen

Activates the TRIM Mode. GUIDE is used with McIntosh Models displaying instructions on a video screen

Press the Trim Push-button and then the LEVEL DOWN Push-button to select and adjust various functions. INFO is used with McIntosh Models displaying information on a video screen

Scrolls through the available INPUTS

Mutes the audio

Selects transport functions of STOP, PLAY/PAUSE, RECORD, BACK for the previous-selection, FAST-REVERSE, FAST-FORWARD and NEXT for the next selection

Selects Previous Tuner Station PRESET

Tuner scans Down the dial to SEEK the next Station

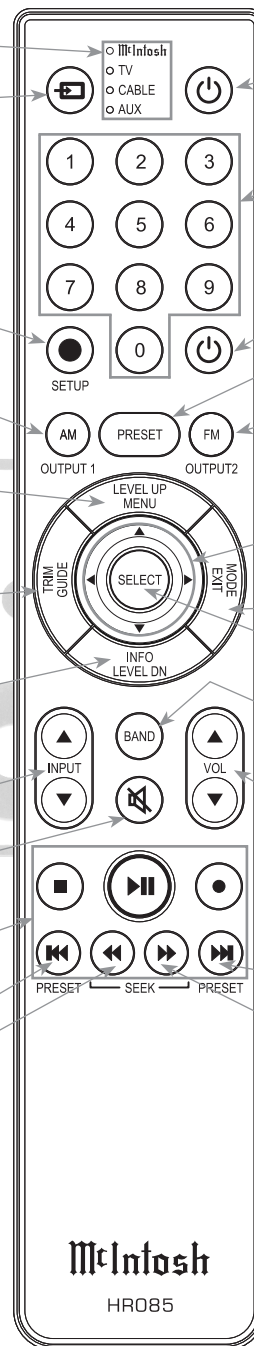

Press to Power the Integrated Amplifier ON

Use to select tuner presets, direct access an AM/FM Station Frequency, disc tracks or any numbered operation

Press to Power the Integrated Amplifier OFF

Direct access to stored Tuner PRESETS when used with the numeric Push-buttons (0 thru 9)

Selects FM Tuner Operating Functions, select Output 2 when used with the SETUP/shift Push-button and Track Selection on certain McIntosh CD Players

Use ▲ and ▼ to tune Up or Down the AM/FM Dial, use ► and ◀ for the next or previous HD Radio Program (were applicable)

EXIT the TRIM Menu and is used with McIntosh Models displaying information or choices on a video screen

Used to SELECT/Enter the indicated choice

Press to change Broadcast BANDs on a connected Tuner. Select certain functions on a variety of McIntosh Models

Adjusts the VOLume level up or down

Selects Next Tuner Station PRESET

Tuner scans Up the dial to SEEK the next Station

Note: Push-buttons whose function is not identified above are for use with other McIntosh Products.

Trim Functions and Settings

The Trim Functions allow you to make changes quickly to many different settings. To access the Trim Menus:

- Press and release the Left (INPUT) Knob
- Navigate by turning the Left Knob
- Change settings by turning the Right (VOLUME) Knob

or use the Remote Control as described “How to use the Remote Control” on page 16.

Trim Function	Default	Settings
BALANCE	Center	Transitions between full left and full right
INPUT TRIM	0dB	-12 dB to +12 dB in 1 dB increments,
EQUALIZER	Off	On or Off
MONO / STEREO	Stereo	Mono or Stereo
METER LIGHTS	On	On or Off
TUBE LIGHTS	On	On or Off
DISPLAY BRIGHTNESS	100%	Brightness adjustments: 25%, 50%, 75% or 100%
HDMI LIP SYNC DELAY (This will only display when the current INPUT is HDMI and Lips Sync Mode is set to Manual)	0 ms	Between 0 ms and 150 ms in 10 ms increments

INPUT Control used to select a source for listening and recording. The control is also used to enter the TRIM or SETUP Modes and select the various functions

Two left Tubes will glow amber when the Left Channel Amplifier POWER GUARD circuit activates and during Tube Warmup.

Two right Tubes will glow amber when the Right Channel Amplifier POWER GUARD circuit activates and during Tube Warmup

VOLUME Control allows adjustment of the listening level for both channels. Also used to change the various TRIM and SETUP Functions

Left Channel Amplifier Output Meter

EQUALIZER Controls increase or decrease the volume levels at the Center Frequencies of 25Hz, 50Hz, 100Hz, 200Hz 400Hz, 1,000Hz, 2,500Hz and 10,000Hz

Right Channel Amplifier Output Meter

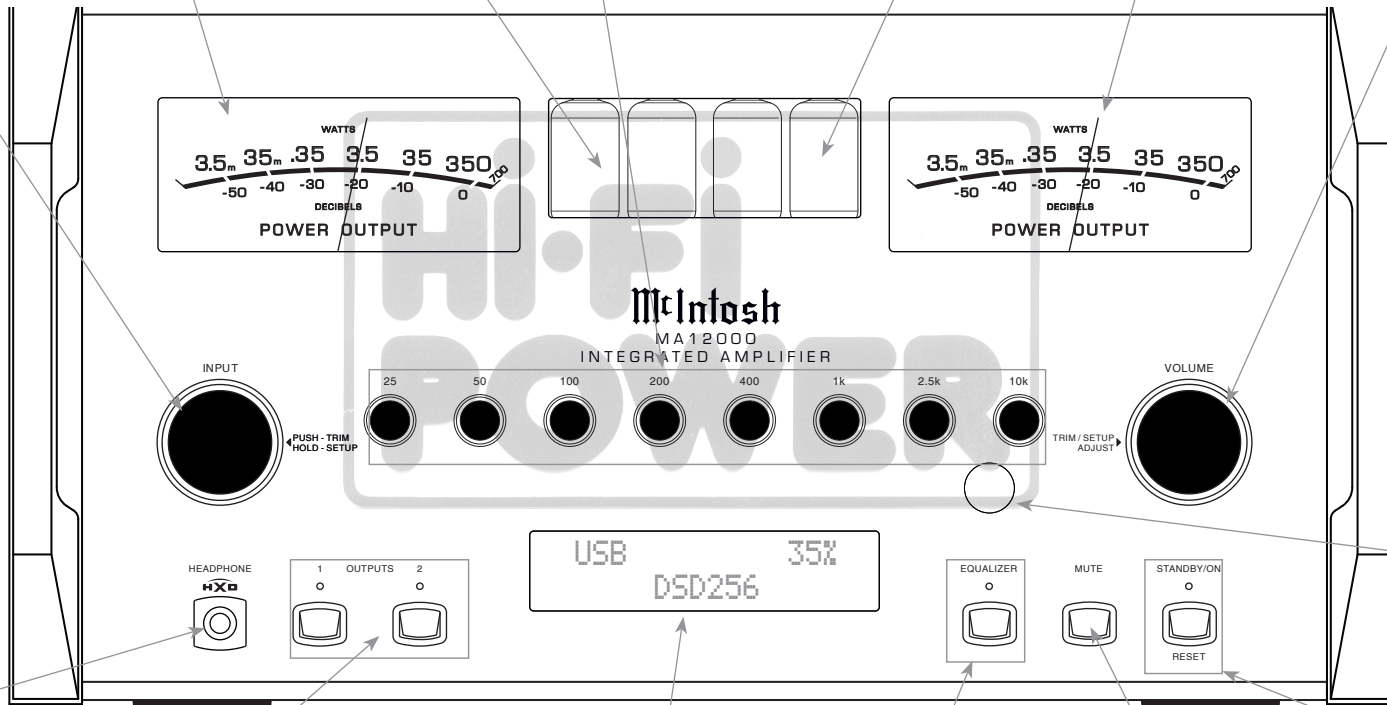

Connection for low impedance dynamic headphones, for private listening

OUTPUT 1 and 2 Push-buttons with indicators, switch Preamplifier Output (Loudspeakers) 1 and 2 On or Off

INFORMATION DISPLAY indicates the Sources, Volume, other Audio Settings, Operational Functions and Setup Mode Settings

EQUALIZER Push-button with indicator, when deactivated the audio signal bypasses the Equalizer Controls

MUTE Push-button mutes the audio from the Loudspeakers and Headphones

STANDBY/ON Push-button with indicator switches the MA12000 ON or OFF (Standby) and resets the microprocessors

IR Sensor receives commands from a Remote Control



How to Operate the Setup Mode

Your McIntosh MA12000 has been factory configured to allow immediate enjoyment of superb audio without the need for further adjustments. If you wish to make changes to the factory default settings, a Setup Feature is provided to customize the operating settings using the Front Panel Information Display. Refer to the MA12000 Front Panel Illustration on the previous page while performing the following steps.

Note: If the MA12000 is currently On, proceed to step 2.

1. Press the STANDBY/ON Push-button on the Front Panel or press the (Power ON) Push-button on the Remote Control to switch On the MA12000. The MA12000 will go through a brief startup initialization with the Front Panel Information Display first indicating “MA12000”, followed by the last used source and volume setting. This is followed by the volume setting indication starting at zero and then increasing to the last used volume setting. Refer to figure 1.



Figure 1

2. Press and hold in the INPUT Control until the Front Panel Information Display indicates “MA12000 V1.00, (or higher Main Firmware version) - S/N: AFG_____” (Serial Number). Refer to figure 2.



Figure 2

3. Rotate the INPUT Control to select the Setup Mode Menu item, “SETUP: Inputs, (Hold INPUT)”. Continue to rotate the INPUT

CONTROL to view the other SETUP Mode Options. Refer to figure 3.



Figure 3

4. To exit from the SETUP Mode, press and hold in the INPUT Control and the Front Panel Display will indicate its normal display. Refer to figure 1.

Default Settings

The Default Settings Chart below indicates the Function Name, Default Setting and options.

Default Settings		
Function Name	Default	Options.
MA12000	V. ___	
DA2	V. ___	
INPUTS	On / Rename	Off
OUTPUTS (1 & 2)	Switched	Unswitched
Output (Headphones)	Mute All	Mute No Outputs
TRIGGER 1	Output 1	Main, Output 2
TRIGGER 2	Output 2	Main, Output 1
DATA PORTS (1 thru 4)	All Data	Specific Input
PASSTHRU	OFF	BAL or UNBAL Inputs
HDMI CEC PWR/VOL	ON	Off
Lip Sync Mode	Auto	Manual
HDMI/OPTI 1 or 2 Gain	0dB	0db to 15dB
RS232 (Rate)	115200 Baud	9600 to 115200
Remote Control Codes	Normal	Alternate
Front IR Sensor	Enabled	Disabled
Auto-Off	Enabled	Disabled

Firmware Version

The MA12000 functionality is controlled by internal software that is known as Firmware. There are two Firmware Identification Numbers for the MA12000. The first Firmware Number is for the Main Circuitry of the MA12000 and can be identified at any time by utilizing the Setup Mode.

1. Press and hold in the INPUT Control to enter Setup Mode.
2. Referring to the Front Panel Information Display the number after the character “V” is the Firmware number. Refer to figure 2.

To view the second Firmware Number, which is for the Digital Audio Circuitry of the MA12000, perform the following steps:

3. Press and hold in the INPUT Control to enter Setup Mode.
4. Rotate the INPUT Control until the Front Panel Information Display indicates “DA2 Firmware, V1.00” (or higher Digital Audio Firmware version). Refer to figure 4.

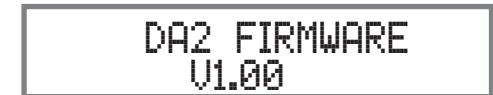

Figure 4

5. To exit the Setup Mode, press the INPUT Control.

Input Settings

The MA12000 provides the ability to switch unused INPUTS Off (or back On if they have been previously switched Off). The default INPUT Names can be changed to match the name of the component connected to it or any other custom name desired (within 10 Characters).

INPUT SWITCHED ON/OFF:

In the following example, the UNBAL 4 Input will be switched Off.

Note: When an INPUT is switched Off, its name will no longer appear on the Front Panel Information Display when using the INPUT Control (Front Panel or Remote Control).

1. Press and hold in the INPUT Control to enter the SETUP MODE.
2. Rotate the INPUT Control until “SETUP: Inputs, (Hold INPUT)” appears on the Information Display.
3. Press and hold in the INPUT Control until “SETUP: UNBAL 4, On / Name (Hold INPUT)” appears on the Display. If necessary rotate the INPUT Control to select the UNBAL 4 Input. Refer to figure 5.



Figure 5

4. To switch the UNBAL 4 Input Off, rotate the VOLUME Control until the display indicates “SETUP: UNBAL 4, Off”. Refer to figure 6.



Figure 6

5. Exit the SETUP Mode by several presses of the INPUT Control.

In the following example, the UNBAL 4 Input will be switched On.

Notes: 1. When an INPUT is switched ON, its name will appear on the Front Panel Information Display when using the INPUT Control (Front Panel or Remote Control).

6. Press and hold in the INPUT Control to enter the

SETUP MODE.

7. Rotate the INPUT Control until “SETUP: Inputs, (Hold INPUT)” appears on the Information Display.
8. Press and hold in the INPUT Control until “SETUP: UNBAL 4, Off” appears on the Display. If necessary rotate the INPUT Control to select the UNBAL 4 Input. Refer to figure 6.
9. To switch the UNBAL 4 Input On, rotate the VOLUME Control until the display indicates “SETUP: UNBAL 4, On / Name”.
10. Exit the SETUP Mode by several presses of the INPUT Control.

RENAME INPUT:

In the following example, the BAL (BALANCED) Input will be renamed to MEDIA SVR.

The MA12000 Default Input Names (UNBAL 1, BAL, COAX 1, etc.) as indicated on the Front Panel Display can be customized to a different name up to ten characters long (TUNER, CD PLAYER, etc.). The available characters for renaming the input include the following: ! < > * , / - _ 0 1 2 3 4 5 6 7 8 9 A B C D E F G H I J K L M N O P Q R S T U V W X Y Z .

In the following example, the BAL Input will be renamed to “MEDIA SVR”.

11. Press and hold in the INPUT Control to enter the SETUP MODE.
12. Rotate the INPUT Control until “SETUP: Inputs, (Hold INPUT)” appears on the Information Display. Refer to figure 7.

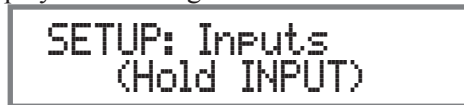

Figure 7

13. Press and hold in the INPUT Control until “SETUP: BAL, On / Rename” appears on the Display. If necessary rotate the INPUT Control to

select the BAL Input. Refer to figure 8.



Figure 8

14. Press and hold in the INPUT Control until “RENAME: BAL, >BAL <” appears on the Display. The character “B” is flashing to indicate it is ready to be changed. Refer to figure 9.



Figure 9

15. Rotate the VOLUME (ADJUST) Control to change the character “B” to “M”. Refer to figure 10.



Figure 10

16. Rotate the INPUT Control until the character “A” is flashing, then rotate the VOLUME (ADJUST) Control to change the character “A” to “E”. Refer to figure 11.



Figure 11

- Repeat this process until the desired word is spelled (in this case “MEDIA SVR”). Refer to Figure 17.



Figure 17

18. To save the new name, press and hold in the INPUT Control until “SETUP: MEDIA SVR ON / Rename” appears on the Front Panel Information

Display. Refer to figure 18.

Figure 18

- Exit the SETUP Mode by several presses of the INPUT Control.

Output Settings

The Output Settings provide the ability to change how the MA12000 Output 1, Output 2 and Headphones function.

OUTPUT 1 and 2:

By default OUTPUT 1 and 2 are set to go On/Off by using the Front Panel OUTPUT 1 and 2 Push-buttons or by using the OUTPUT 1 and 2 Push-buttons on the Remote Control. If it is desirable to have OUTPUT 1 and/or 2 always On regardless of the OUTPUT 1 and 2 Push-button settings, perform the following:

- Press and hold in the INPUT Control to enter the SETUP MODE.
- Rotate the INPUT Control until “SETUP: Outputs, (Hold INPUT)” appears on the Information Display. Refer to figure 19.

Figure 19

“(Hold INPUT)” appears on the Information Display. Refer to figure 19.

Figure 20

- Press and hold in the INPUT Control until “SETUP: OUTPUT 1, Switched” appears on the

Figure 21

Display. Refer to figure 20.

- Rotate the VOLUME (ADJUST) Control to change

Figure 22

Figure 23

from the “Switched” setting to “Unswitched”. Refer to figure 21.

- In a similar manner, perform steps 3 and 4 to change the OUTPUT 2 setting. Refer to figures 22 and 23.

The MA12000 Default Setting for using Headphones is to automatically mute all the Output Connectors when the Headphone Cable Plug is inserted into the MA12000 Front Panel HEADPHONES Jack. There are two available settings:

Figure 24

Mute All Outputs

Figure 25

Mute No Outputs

- Rotate the INPUT Control until “SETUP: HEADPHONES, Mute All Outputs” appears on the Information Display. Refer to figure 24.
- Rotate the VOLUME (ADJUST) Control to change the current HEADPHONES setting from “Mute All Outputs” to “Mute No Outputs”. Refer to figure 25.
- Exit the SETUP Mode by several presses of the INPUT Control.

Power Control Triggers 1 and 2

By default the Power Control TRIGGER 1 and TRIGGER 2 are assigned to activate when Output 1 or Output 2 is selected. Triggers 1 and 2 can be reassigned to function the same as the MAIN Power Control Jack or be assigned to a given Input.

Note: The MAIN Power Control Jack is controlled by the STANDBY/ON Front Panel Push-button and the Remote Control Power Push-buttons.

In the first example, the Power Control Triggers 1 and 2 will be assigned to MAIN:

1. Press and hold in the INPUT Control to enter the SETUP MODE.
2. Rotate the INPUT Control until “SETUP: Triggers, (Hold INPUT)” appears on the Information Display. Refer to figure 26.



SETUP: Triggers
(Hold INPUT)

Figure 26

3. Press and hold in the INPUT Control until “SETUP: TRIGGER 1, Output 1” appears on the Display. Refer to figure 27.



SETUP: TRIGGER 1
Output 1

Figure 27

4. Rotate the VOLUME (ADJUST) Control to select “MAIN” from the available additional selections including Output 2 or Input. Refer to figure 28.



SETUP: TRIGGER 1
Main

Figure 28

5. In a similar manner, perform steps 3 and 4 to change the Trigger 2 setting from OUTPUT 2 to Main. Refer to figures 29 and 30.



SETUP: TRIGGER 2
Output 2

Figure 29



SETUP: TRIGGER 2
Main

Figure 30

In the second example, Trigger 2 will activate when the BAL Input is selected:

6. Rotate the INPUT Control to select “SETUP: TRIGGER 2, Main” appears on the Display. Refer to figure 30.
7. Rotate the VOLUME (ADJUST) Control until “SETUP: TRIGGER 2, Input (Hold INPUT)” appears on the Display. Refer to figure 31.



SETUP: TRIGGER 2
Input (Hold INPUT)

Figure 31

8. Press and hold in the INPUT Control until “SETUP: TRIGGER 2, Bal: OFF” appears on the Display. Refer to figure 32.



SETUP: TRIGGER 2
Bal : OFF

Figure 32

9. Rotate the VOLUME (ADJUST) Control to select “Bal : ON”. Refer to figure 33.



SETUP: TRIGGER 2
Bal : ON

Figure 33

10. Exit the SETUP Mode by several presses of the INPUT Control.

Data Ports

Data Port Connections between the MA12000 and a McIntosh Source Component allow for basic function control of the source component using the MA12000 supplied HR085 Remote Control. By default, all of the four Data Ports are set to send the same Data to the selected source. To dedicate a given Data Port for only one source component (example, source component connected to the BAL Input will be assigned to Data Port 1) perform the following Steps:

1. Press and hold in the INPUT Control to enter the SETUP MODE.
2. Rotate the INPUT Control until “SETUP: Data Ports, (Hold INPUT)” appears on the Information Display. Refer to figure 34.



SETUP: Data Ports
(Hold INPUT)

Figure 34

3. Press and hold in the INPUT Control until “SETUP: DATA PORT 1, All Data” appears on the Display. Refer to figure 35.



SETUP: DATA PORT 1
All Data

Figure 35

4. Rotate the VOLUME (ADJUST) Control to select the “BAL” Input. Refer to figure 36.



SETUP: DATA PORT 1
BAL

Figure 36

5. In a similar manner, perform steps 3 and 4 to assign any additional Data ports.
6. Exit the SETUP Mode by several presses of the INPUT Control.

Passthru

When the MA12000 is part of a Home Theater or Multichannel Audio System the Right and Left Front Channels from an Audio/Video Processor or Surround Decoder can “Passthru” from the assigned MA12000 Input, into the MA12000 Power Amplifier Circuitry. The “Passthru” Audio Signal is also available for a separate external Power Amplifier(s) via the number 1 Preamplifier Output Jacks. The Setup Mode allows selection of the specified MA12000 Input to be used for the Right and Left Front Channels. In the example below, the Right and Left Front Channels from the Audio/Video Processor will be connected to the UNBALANCED 6 INPUT Jacks on the MA12000. Refer to page 9 for additional connection information.

Note: The Phono and Digital Inputs are not assignable as a Passthru Input.

1. Press and hold in the INPUT Control to enter the SETUP MODE.
2. Rotate the INPUT Control until “SETUP: Passthru, Off” appears on the Information Display. Refer to figure 37.



SETUP: Passthru
Off

Figure 37

3. Rotate the VOLUME (ADJUST) Control to select “SETUP: Passthru, UNBAL 6” Input. Refer to figure 38.



SETUP: Passthru
UNBAL 6

Figure 38

4. Exit the SETUP Mode by several presses of the INPUT Control.

Comm Port Baud Rate

The MA12000 may be remotely controlled from other equipment connected to the Rear Panel RS232 Jack. The speed at which the MA12000 communicates (8 bit, no parity and 1 stop bit) with other equipment is adjustable from 9,600 bits per second to 115,200 bits per second. To change from the default speed of 115,200 bits per second, perform the following steps:

1. Press and hold in the INPUT Control to enter the SETUP MODE.
2. Rotate the INPUT Control until “SETUP: RS232, 115200 Baud” appears on the Information Display. Refer to figure 40.



SETUP: RS232
115200 Baud

Figure 40

3. Rotate the VOLUME (ADJUST) Control to select the desired Baud Rate Speed.
4. Exit the SETUP Mode by several presses of the INPUT Control.

Remote Control Codes

The HR085 Remote Control, included with the MA12000, utilizes the NORMAL McIntosh Control Codes. The second set of Control Codes the MA12000 will respond to is referred to as the ALTERNATE Codes. The Alternate Codes are used when the MA12000 is used in the same location as another McIntosh Preamplifier and/or A/V Processor. This will prevent the Remote Control from affecting the operation of both units at the same time. To activate the Remote Control ALTERNATE Codes perform the following steps:

1. Press and hold in the INPUT Control to enter the SETUP MODE. Refer to figure 2 on page 17.
2. Rotate the INPUT Control until “SETUP: IR Codes, Normal” appears on the Information Display. Refer to figure 41.



SETUP: IR Codes
Normal

Figure 41

3. Rotate the VOLUME (ADJUST) Control to the Alternate Codes. Refer to figure 42.

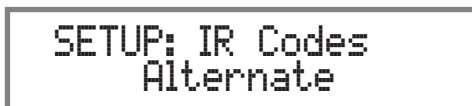

SETUP: IR Codes
Alternate

Figure 42

4. It is now necessary to change the HR085 Remote Control over to the Alternate Codes. Information on the HR085 Remote Control is available for download from the McIntosh Web Site:

<http://www.mcintoshlabs.com/us/Products/pages/ProductDetails.aspx?CatId=preamplifiers&ProductId=MA12000>

5. Exit the SETUP Mode by several presses of the INPUT Control.

IR Sensor

The MA12000 Front Panel Sensor, which receives the signals from the HR085 Remote Control, can be switched off to prevent interference when an external IR Sensor is connected. To de-activate the Front Panel IR Sensor perform the following steps:

1. Press and hold in the INPUT Control to enter the SETUP MODE. Refer to figure 2 on page 17.
2. Rotate the INPUT Control until “SETUP: Front IR, Enabled” appears on the Information Display. Refer to figure 43.



SETUP: Front IR
Enabled

Figure 43

3. Rotate the VOLUME (ADJUST) Control to select



SETUP: Front IR
Disabled

Figure 44

Disabled. Refer to figure 44.

5. Exit the SETUP Mode by several presses of the INPUT Control.

Power Mode

The MA12000 incorporates an Auto Off Feature, which automatically places the preamplifier into the Power Saving Standby/Off Mode. This occurs approximately 30 minutes after there has been an absence of user activity (includes changes to any of the Operation Functions such as source selection, volume adjustment, etc.) or absence of an audio signal. If it is desirable to disable the Auto Off Feature perform the following steps:

1. Press and hold in the INPUT Control to enter the SETUP MODE. 2. Rotate the INPUT Control until “SETUP: Auto Off, Enabled” appears on the Information Display. Refer to figure 45.
3. Rotate the VOLUME (ADJUST) Control to select



SETUP: Auto Off
Enabled

Figure 45

Disabled. Refer to figure 46.



SETUP: Auto Off
Disabled

Figure 46

4. Press the INPUT Control to exit the Setup Mode.

Factory Reset

If it becomes desirable to reset all the adjustable settings (Setup and Trim Settings) to the factory default values, perform the following steps:

1. Press and hold in the INPUT Control to enter the SETUP MODE. Refer to figure 2 on page 17.
2. Rotate the INPUT Control until “FACTORY RESET, (Hold INPUT)” appears on the



Figure 47

Information Display. Refer to figure 47.

3. Press and hold in the INPUT Control until “FACTORY RESET, In Progress!” appears on the Information Display, then release the INPUT



Figure 48



Figure 49

Control. Refer to figures 48 and 49.

4. Press the Front Panel STAND/BY Push-button to switch On the MA12000.

Reset of Microprocessors

In the unlikely event the controls of the MA12000 stop functioning, the microprocessors can be reset by performing the following:

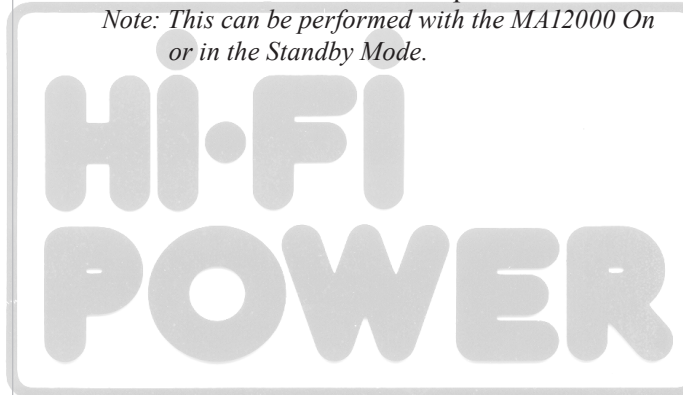

1. Press the STANDBY/ON Push-button until the STANDBY/ON LED Indicator switches Off in approximately five seconds.
2. Then release the STANDBY/ON Push-button and the MA12000 will switch Off.
3. When the STANDBY/ON LED is illuminated press the STANDBY/ON Push-button, the MA12000 will resume normal operation.

Note: This can be performed with the MA12000 On or in the Standby Mode.



How to Operate the MA12000

Power On and Off

The Red LED above the STANDBY/ON Push-button lights to indicate the MA12000 is in Standby mode. To switch ON the MA12000, Press the STANDBY/ON Push-button on the Front Panel or press the  (Power - Green) Push-button on the Remote Control. The MA12000 will go through a brief startup initialization with the Tubes glowing Amber. This is followed by the volume setting indication starting at zero and then increasing to the last used volume setting. When Tube warmup is complete, the Tubes will glow green (or off if TUBE LIGHTS Trim setting is set to Off). To switch OFF the MA12000, press the STANDBY/ON Push-button on the Front Panel or the  (Power - Red) Push-button on the Remote Control.

Source Selection

Rotate the INPUT Control to select the desired source or press the INPUT Up▲ or Down▼ Push-button on the Remote Control. Refer to figure 53.

Volume Control

Rotate the Front Panel VOLUME Control or use the VOLume Up▲ or Down▼ Push-buttons on the Remote Control for the desired listening level. Refer to figure 53.

Trim Functions

The MA12000 has various Trim Selections with Adjustments. The Trim Functions include Balance, Input Trim Level, Equalizer Mode, Phono Cartridge Loading when a Phono Input is selected (Resistance for MC and Capacitance for MM), Mono/Stereo,

Meter Backlight, Display Brightness and HXD Mode (when Headphones are connected). The Trim Settings are stored in memory independently for each Input Source Selected, except the Meter Illumination which is the same for all inputs.

Note: Selection and Adjustment of all Trim Functions may be performed by pressing the Front Panel INPUT Trim Control and then rotating it to select the desired Trim Function. Then use the VOLUME Adjust Control to change the setting. Remote Control TRIM Push-Button together with the LEVEL UP/Down Push-button may also be used.

After approximately 5 seconds the Display returns to indicate the Source Selection and Volume Level.

Balance

Listening balance varies with different program sources, room acoustics and listening positions relative to the Loudspeakers. Use the Balance (Trim Function) as needed to achieve approximately equal listening volume levels in each Loudspeaker. To adjust the Balance perform the following:

1. Press the TRIM Push-button repeatedly on the Remote Control until “L

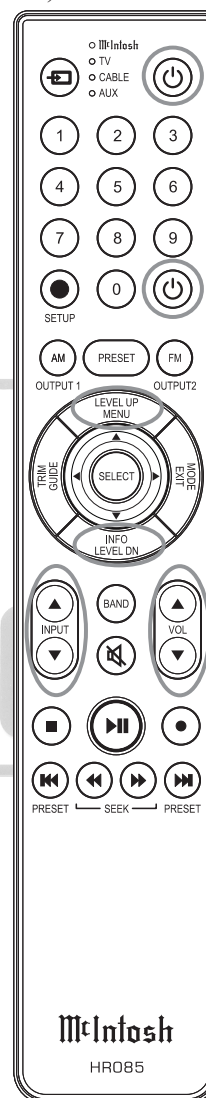

Figure 53

BALANCE R, ||” appears on the Front Panel Display. Refer to figure 54.



Figure 54

Note: The Front Panel INPUT/Trim Control may also be used.

2. Rotate the VOLUME/Adjust Control or press the LEVEL UP / DOWN Push-buttons on the Remote Control to emphasize the Right Channel (refer to figure 55) or the Left Channel (refer to figure 56).



Figure 55



Figure 56

The Front Panel Display indicates the relative Balance changes. After approximately 5 seconds, the Display returns to indicate the Source Selection and Volume Level. To verify the Balance setting without changing it, use the TRIM Push-button and select Balance.

Equalizer Mode

The built-in eight band Frequency Equalizer provides more precise adjustment of sound than Bass and Treble Controls. By default, the Equalizer is Off for all Input Sources and the Equalizer Circuitry is bypassed. Any Input Source may be assigned to have the Equalizer On when selected. To activate the Equalizer

for a given Input Source, perform the following steps:

Note: The audio signal present at the FIXED OUT Jacks is unaffected by the Equalizer settings.

1. Select the desired Input Source.
2. Select “EQUALIZER, Off” as indicated on the Front Panel Information Display. Refer to figure 57.



Figure 57

3. Set the EQUALIZER On for the desired Input by using the Front Panel Volume Control or the Remote Control Push-buttons may also be used to switch the Equalizer On. Refer to figure 58.



Figure 58

After approximately 5 seconds the Information Display returns to indicate the Source Selection and Volume Level.

Trim Level

Source Components can have slightly different volume levels resulting in the need to readjust the Volume Control when switching between different sources. The MA12000 allows the adjustment of levels for each Source, ensuring the same relative volume. To adjust the Trim Level for the currently selected Input Source perform the following steps:

1. Select “INPUT TRIM” as indicated on the Front Panel Information Display. refer to figure 59.



Figure 59

2. Adjust the Trim Level of each Input to match the average volume level of the Input most frequently listened to. The range of adjustment is ± 6.0 dB in half dB steps. Refer to figures 60 and 61.



Figure 60



Figure 61

After approximately 5 seconds the Information Display returns to indicate the Source Selection and Volume Level.

Phono Adjustments

When a Phono Input (MC or MM) is selected, an additional TRIM SELECT FUNCTION becomes available for adjustment. Perform the following steps to make the Phono Trim Adjustment:

1. Select the MC Phono Source Input.
2. Select TRIM “PHONO RESISTANCE, 400 Ω ” as indicated on the Front Panel Information Display. Refer to figure 62A.



Figure 62A

3. Rotate the VOLUME/Adjust Control or press the LEVEL UP / DOWN Push-buttons on the Remote Control to select the Resistance Load that comes closest to the Phono Cartridge Makers recommended value.

4. Temporarily exit TRIM Mode.
5. Select the MM Phono Input.
6. Select TRIM “PHONO CAPACITANCE, 50pF” as indicated on the Front Panel Information Display. Refer to figure 62B.



Figure 62B

7. Rotate the VOLUME/Adjust Control or press the LEVEL UP / DOWN Push-buttons on the Remote Control to select the Capacitance Load that comes closest to the Phono Cartridge Makers recommended value.

After approximately 5 seconds the Alphanumeric Display returns to indicate the Source Selection and Volume Level.

Mono/Stereo Mode

By default the Stereo Mode is active for all Input Sources however, any Input Source may be assigned to Mono Mode. To change Stereo Mode to Mono for a given Input Source, perform the following steps:

Note: The audio signal present at the FIXED OUT Jacks is affected by the Stereo/Mono setting.

1. Select the desired Input Source.
2. Select “MONO / STEREO, _____” as indicated on the Front Panel Information Display. Refer to figure 63.



Figure 63

3. To select MONO Mode adjust the TRIM LEVEL. Refer to figure 64.



Figure 64

After approximately 5 seconds the Information Display returns to indicate the Source Selection and Volume Level.

Meter Backlight

The Front Panel Meter Illumination may be switched On or Off by performing the following:

1. Select “METER LIGHTS, On” as indicated on the Front Panel Information Display. See figure 65.



Figure 65

2. Switch Off the Meter Illumination. See figure 66.



Figure 66

After approximately 5 seconds the Information Display returns to indicate the Source Selection and Volume Level.

- Notes:*
1. Meter Illumination of recent McIntosh Power Amplifiers will also switch On/Off when connected to the MA12000 via a power control cable.
 2. Some A/V Processors will provide an On/Off Control Signal when the MA12000 Passthru Input Jack is connected to the A/V Processor via the power control cable.

INFORMATION DISPLAY ILLUMINATION

The Brightness Level of the Front Panel Information Display can be adjusted from bright to dim by

performing the following:

1. Select “DISPLAY BRIGHTNESS” as indicated on the Front Panel Information Display. Refer to figure 67.



Figure 67

2. Reduce the Brightness level by adjusting the TRIM LEVEL. Refer to figure 68.



Figure 68

After approximately 5 seconds the Information Display returns to indicate the Source Selection and Volume Level.

Headphone HXD

When headphones are connected to the MA12000 Front Panel Jack, an additional TRIM function

becomes available. McIntosh’s HXD brings the acoustical depth and spatiality of music normally heard with loudspeakers, to your headphones. The default setting is HXD On. To switch HXD Off perform the following:

1. Momentarily press the INPUT Control, then rotate it to select “HEADPHONE HXD, On”. Refer to figure 69.



Figure 69

2. To deactivate the HXD Mode rotate the VOLUME Adjust Control until the Front Panel Display indicates “HEADPHONE HXD, Off”. Refer to figure 70.



Figure 70

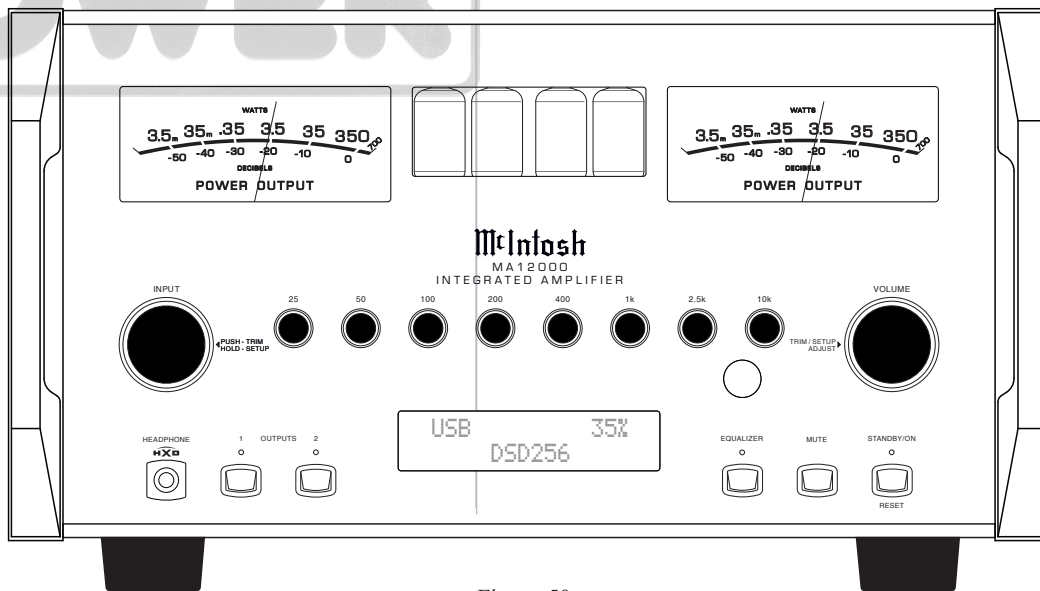

Figure 50

Equalizer

Press the Front Panel EQUALIZER Push-button to activate the MA12000 Equalizer Control Circuitry for the currently selected Input Source. The LED above the EQUALIZER Push-button will illuminate. The MA12000 remembers for each selected Input whether the Equalizer Control Circuitry is activated or deactivated. To deactivate the Equalizer Control Circuitry for the currently selected Input Source, press the EQUALIZER Push-button and the LED above the push-button will extinguish.

Note: 1. The audio signal present at the FIXED OUTPUT Jacks is unaffected by the Equalizer Circuitry.

Trim

Press the Front Panel INPUT/TRIM Control to activate the MA12000 Trim Functions. Rotate the Front Panel INPUT/Trim Control to select the desired Trim Function and then rotate the VOLUME/Adjust Control to vary or make changes. Refer to figure 50. The Remote Control TRIM and LEVEL UP and LEVEL DOWN Push-buttons may also be used. Approximately 5 seconds after Trim Function Selection and/or adjustments have stopped, the the Trim Mode switch off.

Mute

Press the MUTE Push-button to Mute the Audio in Output 1 (Loudspeakers), Output 2 and Headphones. The audio signals present at the FIXED OUTPUT Jacks are not effected by activating the mute function. The Front Panel Display will indicate the Source Name and with the word MUTE in place of the actual volume setting. Refer to figure 71.



Figure 71

Pressing the Mute Push-button a second time or adjusting the volume control will un-mute the MA12000.

Headphones Jack

Connect a pair of dynamic headphones to the Headphone Jack with a 1/4" (0.635cm) stereo phone type plug for private listening. The default setting is for Output Connections 1 and 2 to automatically mute. For additional Information refer to "HEADPHONE HXD" on this page.

Note: The Headphone Output is optimized for impedances ranging from 100 to 600 ohms.

Power Output Meters

The MA12000 Power Output Meters indicate the power delivered to the Loudspeakers. Refer to figure 72.

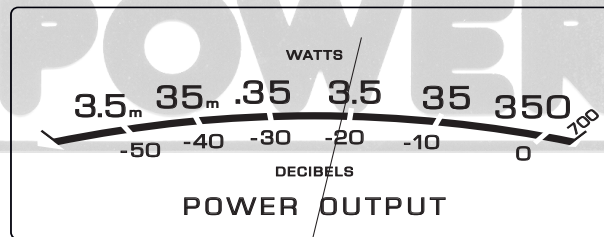

Figure 72

The meters respond to all the musical information being produced by the Amplifier. They indicate to an accuracy of at least 95% of the power output with only a single cycle of a 2,000Hz tone burst.

Using a Separate Power Amplifier

There are two different ways to use a separate power amplifier with a MA12000. The first way is to use the

separate amplifier instead of the MA12000 built-in Power Amplifier. Connect the Loudspeakers to the separate Power Amplifier and remove the McIntosh Jumpers that are located between the OUTPUTS 1 Jacks and the PWR AMP INPUT Jacks. Refer to figure 73.

Note: The McIntosh Jumpers must be connected,

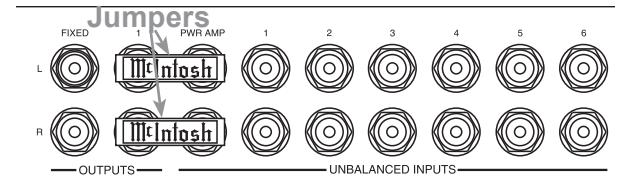

Figure 73

between the above mentioned jacks, when the MA12000 Internal Power Amplifier is to be used.

The second way is to use both a separate Power Amplifier and the MA12000 built-in Power Amplifier. Connect one pair of Loudspeakers to the separate Power Amplifier and the second pair to the MA12000. Refer to the MA12000 Output Connection Diagrams located on the separate folded sheet "Mc2B" and figure 74.

Note: The MA12000 VOLUME Control will affect the sound

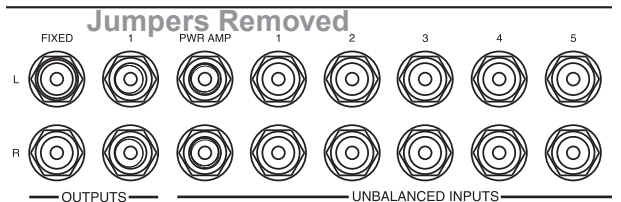

Figure 74

level of all the Loudspeakers.

Using Output 2

The MA12000 has provisions for connecting an external Power Amplifier (to drive Loudspeakers in another room) and an external sensor for remote

operation of the MA12000 from that room. With an external Power Amplifier connected (as illustrated on the McIntosh Connection Diagram separate sheet “**Mc2B**”), press the Front Panel OUTPUT 2 Push-button or press on the Remote Control, the BLUE (Setup) Push-button followed by pressing the OUTPUT 2 Push-button to switch On or Off the external Power Amplifier.

Passthru

When the MA12000 is connected together with a McIntosh Multichannel A/V Control Center or Surround Decoder and has the PASSTHRU Mode activated, it will automatically turn-on when the A/V Processor or Surround Decoder is turned On. It will indicate on the Front Panel Display “PASSTHRU”. Refer to figure 75.



Figure 75

The MA12000 OUTPUT 1 / OUTPUT 2 Front Panel Push-buttons are active when in the Passthru Mode. The other Front Panel Controls and Push-buttons are deactivated as long as the Passthru Mode is active.

Optical and Coaxial Digital Inputs

When a Digital Input (Optical or Coaxial Connection) on the MA12000 is selected, the Front Panel Display will indicate the sample rate when a signal is present such as “48kHz”.

During the time there is no Digital Signal present on the selected input the display will indicate “_____”.



Equalizer Controls

The MA12000 has eight signal strength controls that can pass through, amplify or attenuate each, all or any combination of the marked equalizer frequencies.

Equalization frequencies are set to 25Hz, 50Hz, 100Hz, 200Hz, 400Hz, 1,000Hz, 2,500Hz and 10,000Hz.

Frequency Controls are individually adjustable and can provide up to +12dB maximum amplification and -12dB attenuation.

Placing any Control Knob in the center detent position removes the tone circuit components from the signal path allowing the frequency of interest to pass through unaltered.

The illustration to the right shows the fundamental frequency range of acoustical musical instruments and the human voice. It also shows the range of adjustment of frequencies for each of the Equalizer Controls of the MA12000 at the +6dB and -6dB points.

Fundamental Frequencies of Acoustical Musical Instruments and the Human Voice

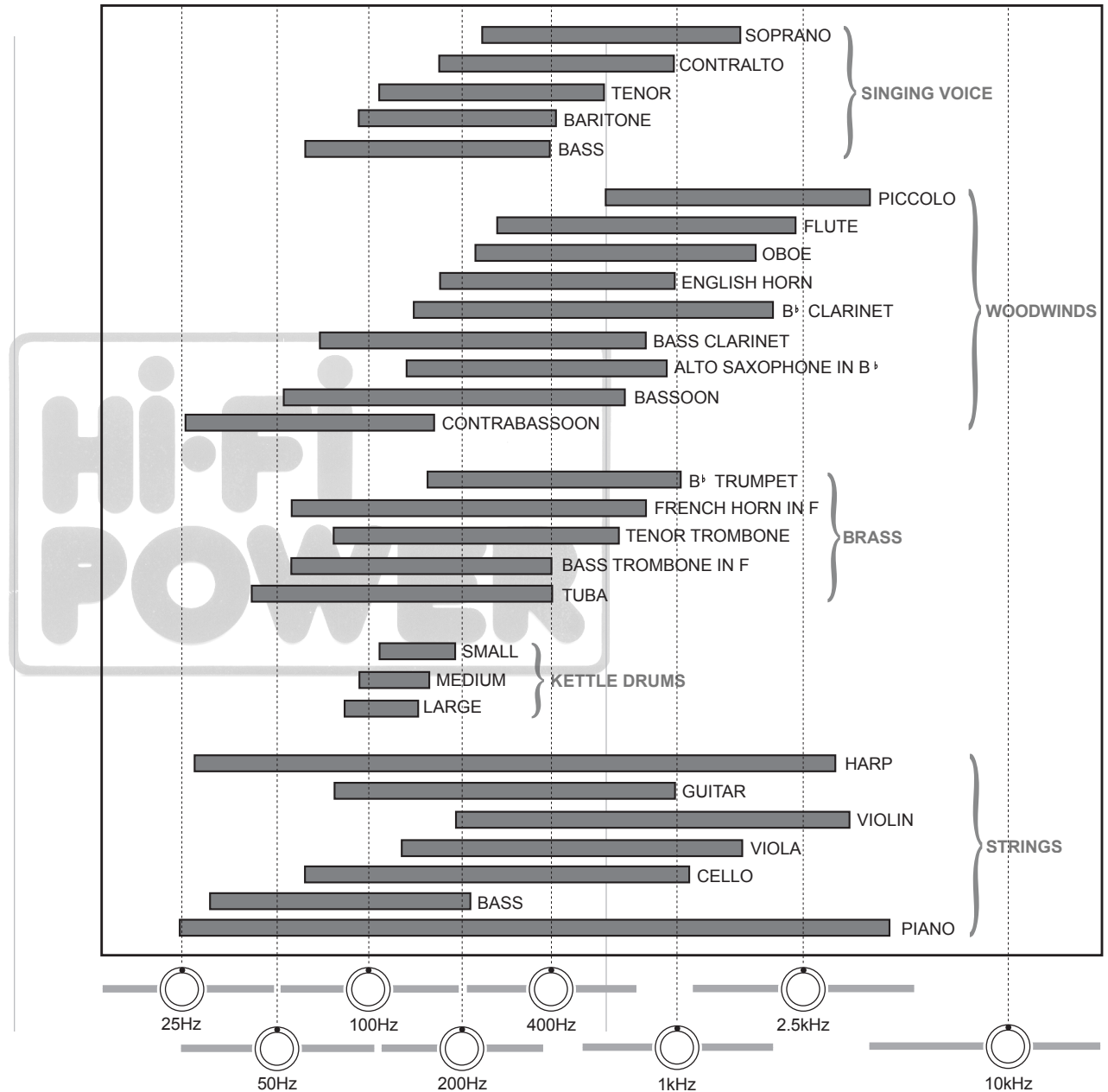

Preamplifier Specifications

Total Harmonic Distortion

0.03% maximum 20Hz to 20,000Hz

Intermodulation Distortion

0.03% maximum for any combination of frequencies from 20Hz to 20,000Hz

Frequency Response

+0, -0.5dB from 20Hz to 20,000Hz

+0, -3dB from 10Hz to 100,000Hz

Preamplifier Output 1 and 2 (for rated input)

1.7V unbalanced (8V Maximum)

3.4V balanced (8V Maximum)

Preamplifier Output Impedance

220 ohms

Sensitivity (for rated output)

High Level - 300mV unbalanced
600mV balanced

Phono MM, 3.0mV

Phono MC, 0.3mV

Signal To Noise Ratio (A-Weighted)

High Level, 95dB below rated output

Phono MM, 77dB below 3mV input

Phono MC, 75dB below 0.3mV input

Input Impedance

High Level - 22K ohms Unbalanced

44k ohms Balanced

Phono MM - 50 to 400pF, in 50pF steps;

47K ohms

Phono MC - 50, 100, 200, 400 or 1,000 ohms;

100pF

Maximum Input Signal

High Level, 8V unbalanced, 16V balanced

Phono MM, 80mV

Phono MC, 8mV

Headphone Impedance

100 to 600 ohms

Equalizer Controls

25Hz, 50Hz, 100Hz, 200Hz, 400Hz, 1,000Hz,

2,500Hz and 10,000Hz

Voltage Gain

High Level to Rec Output: 0dB

High Level to Output 1 and 2: 15dB

Phono MM to Rec Output: 40dB

Phono MC to Rec Output: 60dB

Phono MM to Output 1 and 2: 55dB

Phono MC to Output 1 and 2: 75dB

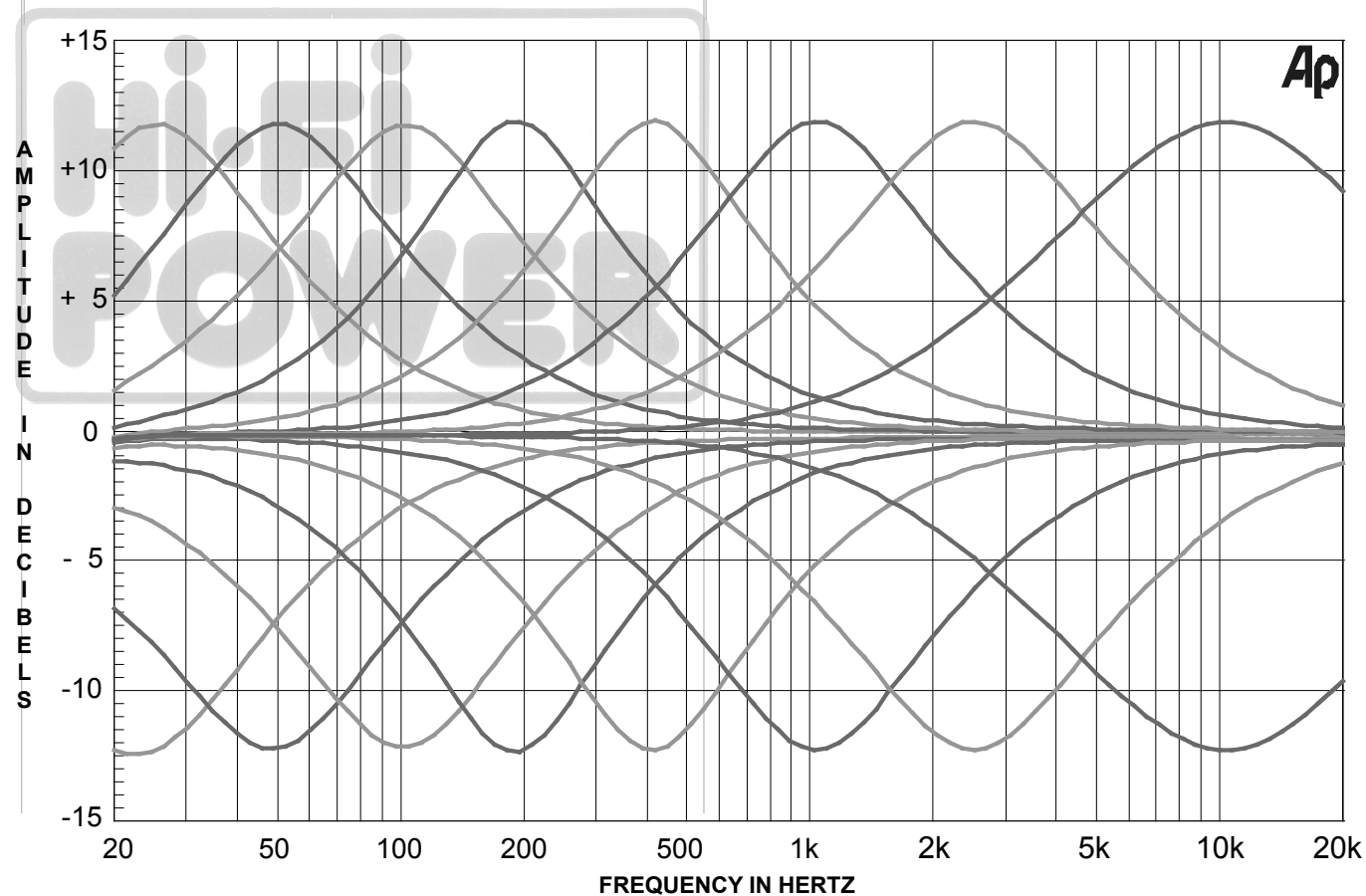



Digital Audio Specifications

Digital Input Signal Format

Coaxial and Optical Inputs - SPDIF (PCM)
MCT and USB Inputs - PCM, DSD
HDMI (ARC)- PCM, Dolby Digital, DTS

Digital Input Sample Rate

Optical: PCM - 16Bit, 24Bit - 44.1kHz to 192kHz
Coaxial: PCM -16Bit, 24Bit - 44.1kHz to 192kHz
MCT: PCM, SACD, -16Bit, 24Bit - 44.1kHz to 192kHz
USB: PCM - 16Bit, 24Bit, 32Bit - 44.1kHz to 384kHz
DXD - DXD352.8kHz, DXD384kHz
DSD - DSD64, DSD128, DSD256, DSD512
HDMI: PCM 24bit, 44.1kHz - 192kHz
DTS
Dolby Digital

Digital Inputs

Coaxial: 0.5V p-p/75 ohms
Optical: -15dbm to -21dbm (TOS Link)
MCT: 0.5V p-p/75 ohms
USB: USB Type B Connector

Power Amplifier Specifications

Power Output

Minimum sine wave continuous average power output per channel, with both channels operating is:
350 watts into 2 ohm load
350 watts into 4 ohm load
350 watts into 8 ohm load

Output Load Impedance

2, 4 or 8 ohms

Rated Power Band

20Hz to 20,000Hz

Total Harmonic Distortion

0.005% maximum with both channels operating from 250 milliwatts to rated power, 20Hz to 20,000Hz

Intermodulation Distortion

0.005% maximum, if the instantaneous peak power output does not exceed twice the rated power output for any combination of frequencies from 20Hz to 20,000Hz.

Dynamic Headroom

1.5dB

Wide Band Damping Factor

Greater than 40

Power Guard

Less than 2% THD with up to 16dB overdrive at 1,000Hz

Frequency Response

+0, -0.25dB from 20Hz to 20,000Hz
+0, -3.0dB from 10Hz to 100,000Hz

Input Sensitivity (for rated output)

1.7 Volts

Signal To Noise Ratio (A-Weighted)

114dB below rated output)

Input Impedance

22,000 ohms

Maximum Input Signal

Power Amplifier In, 16V

Voltage Gain

29dB, 8 Ohms

26dB, 4 Ohms

23dB, 2 Ohms

General Specifications

Power Control and Trigger Output

12VDC, 25mA

Power Requirements

Field AC Voltage conversion of the MA12000 is not possible. The MA12000 is factory configured for one of the following AC Voltages:

100 Volts, 50/60Hz at 8.0 amps

110 Volts, 50/60Hz at 6.6 amps

120 Volts, 50/60Hz at 6.6 amps

127 Volts, 50/60Hz at 6.6 Amps

220 Volts, 50/60Hz at 3.6 amps

230 Volts, 50/60Hz at 3.3 amps

240 Volts, 50/60Hz at 3.3 amps

Standby: Less than 0.25 watt

Note: Refer to the rear panel of the MA12000 for the correct voltage.

Overall Dimensions

Width is 17-1/2 inches (44.45cm)

Height is 9-7/16 inches (24.0cm) including feet

Depth is 22 inches (55.88cm) including the Front Panel, Knobs and Cables

Weight

108 pounds (48.9 kg) net, 141 pounds (63.9 kg) in shipping carton

Shipping Carton Dimensions

Width is 29-1/2 inches (74.93cm)

Height is 17 inches (43.18cm)

Depth is 29 inches (73.66cm)

Packing Instructions

In the event it is necessary to repack the equipment for shipment, the equipment must be packed exactly as shown below. It is very important that the four plastic feet are attached to the bottom of the equipment. Two 1/4-20 x 2-1/4 inch screws and washers must be used to fasten the unit securely to the bottom pad and wood skid. This will ensure the proper equipment location on the bottom pad. Failure to do this will result in shipping damage.

Use the original shipping carton and interior parts only if they are all in good serviceable condition. If a shipping carton or any of the interior part(s) are needed, please call or write Customer Service Department of McIntosh Laboratory. Refer to page 2.

MA12000 Packing Material List

Quantity	Part Number	Description
1	034052	Shipping carton top
1	034051	Shipping carton bottom
2	034186	Front and rear foam pad
2	034187	Side foam pad
2	034054	Top and bottom foam pad
1	034136	Inner carton top
1	034137	Inner carton bottom
1	034188	Inner foam pad
1	034479	Shipping skid
4	401212	1/4-20 hex cap x 2-1/4 inch screw
2	104058	1/4 inch flat washer 1-1/2 inch
4	017937	Plastic foot
4	404080	#10 flat washer

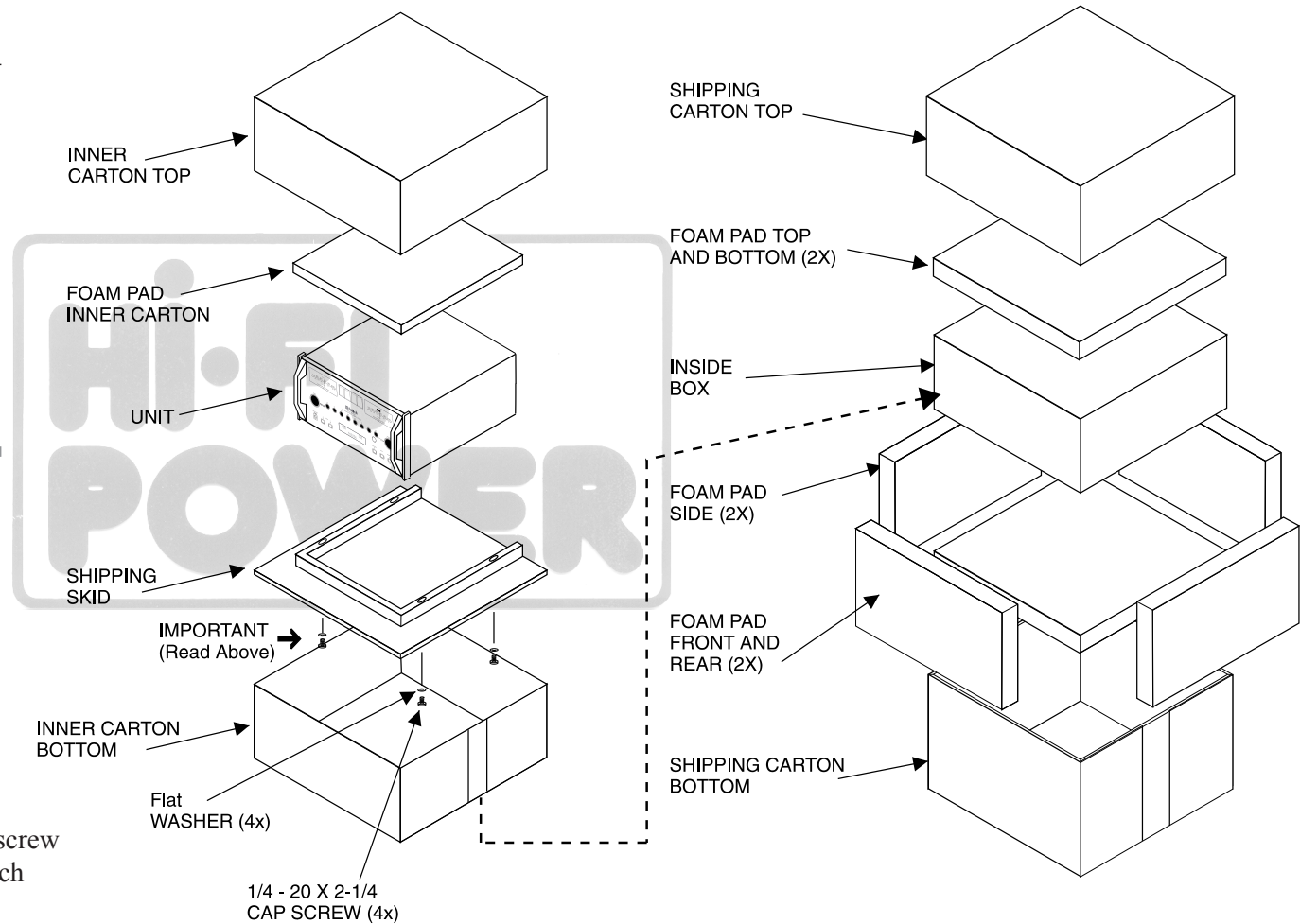



McIntosh Laboratory, Inc.
2 Chambers Street
Binghamton, NY 13903
www.mcintoshlabs.com

The continuous improvement of its products is the policy of McIntosh Laboratory Incorporated who reserve the right to improve design without notice.
Printed in the U.S.A.

McIntosh Part No. 24110100



HOME &
PROFESSIONAL
AUDIOVISUAL

• MAPNH 8 AΘHNA 10433 • THA. 210 3845676 - 210 3845272 FAX. 210 3809747 • e-mail: sales@hifipower.gr •