



Thank You from all of us at McIntosh

You have invested in a precision instrument that will provide you with many years of enjoyment. Please take a few moments to familiarize yourself with the features and instructions to get the maximum performance from your equipment. If you need further technical assistance, please contact your dealer who may be more familiar with your particular setup including other brands. You can also contact McIntosh with additional questions or in the unlikely event of needing service.

McIntosh Laboratory, Inc.

2 Chambers Street
Binghamton, New York 13903

Technical Assistance (607) 723-3512
Fax (607) 724-0549

Customer Service (607) 723-3515
Fax (607) 723-1917

Email support@mcintoshlabs.com

Website www.mcintoshlabs.com

Please Take A Moment

For future reference, you can write down your serial number and purchase information here. We can identify your purchase from this information if the occasion should arise:

Serial Number: _____

Purchase Date: _____

Dealer Name: _____

Table of Contents





General Information	3
Connector and Cable Information.. .. .	3
Performance Features.. .. .	4
Dimensions	5
Installation	5
Front Panel Knobs and Buttons.. .. .	6
Inputs	7
Outputs.. .. .	7
How to use the Remote Control	9
Setup Menus	10
Digital Setup Menu	12-13
Inputs Setup Menu	13
Outputs Setup Menu	14
Triggers Setup Menu	15
Data Out Setup Menu	15
External Control Setup Menu.	16
System Configurations	17
Connecting Components.. .. .	17
Network Information Menu	18
Trim Functions Menu.. .. .	18-19
Equalizer Controls	19
How to Operate the C2800.. .. .	20-21
Specifications	22
Packing Instructions	23
Parts List	23

Safety First

Please read the safety instructions included in a separate document called **Important Additional Operation Information Guide**.

Trademark and License Information

The McIntosh C2800 incorporates copyright protected technology that is protected by U.S. patents and other intellectual property rights. The C2800 uses the following technologies:

Trademark	License Information
	ASIO is a trademark and software of Steinberg Media Technologies GmbH
	Manufactured under license from Dolby Laboratories. Dolby, Dolby Audio, and the double-D symbol are trademarks of Dolby Laboratories.
	For DTS patents, see http://patents.dts.com . Manufactured under license from DTS, Inc. DTS, the Symbol, DTS and the Symbol together, and Digital Surround are registered trademarks and/or trademarks of DTS, Inc. in the United States and/or other countries. DTS, Inc. All Rights Reserved.
	The terms HDMI, HDMI High-Definition Multimedia Interface, and the HDMI Logo are trademarks or registered trademarks of HDMI Licensing Administrator, Inc.

General Information

1. Do not apply AC Power to the C2800 and other Component(s) until they are connected to the C2800 so operational malfunctioning does not occur.
2. Balanced and Unbalanced Inputs and Outputs can be mixed. For example, you may connect signal sources to Unbalanced Inputs and send signals from the Balanced Outputs. You can also use Balanced and Unbalanced Outputs simultaneously, connected to different Power Amplifiers.
3. The C2800 internal Digital to Analog Converter Circuitry is designed to decode PCM, DSD and DTS Digital Signals. The Coaxial and Optical Digital Audio Inputs are for PCM Digital Signals, Dolby Signals and DTS Signals. The C2800 also decodes USB and HDMI (ARC) Digital Signals. Other Digital Audio Signal Format Types will cause the Audio Outputs of the C2800 to be muted.
4. The McIntosh C2800 is factory configured for immediate use. It can also be customized to complement the components making up your system. Refer to the Setup Menu described on page 11.
5. The Remote Control Supplied with the C2800 Preamplifier is capable of operating other components. For additional information go to www.mcintoshlabs.com.
6. The IR Input is configured for non-McIntosh IR sensors such as a Xantech Model HL85BK Kit. Use a Connection Block such as a Xantech Model ZC21 when two or more IR sensors need to be connected to the C2800. The signal from a connected External IR Sensor will have priority over the signal from the Front Panel IR Sensor.
7. For additional information on the C2800 and other McIntosh Products please visit the McIntosh website at www.mcintoshlabs.com.

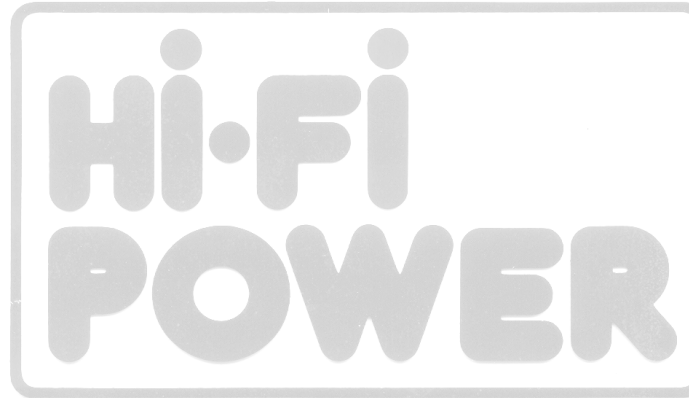

Introduction

The McIntosh C2800 Tube Preamplifier is one of the finest Preamplifiers ever created with connections for both analog and digital sources. The C2800 Outputs have the ability to drive multiple Power Amplifiers. The C2800 reproduction is sonically transparent and absolutely accurate. The McIntosh Sound is “The Sound of the Music Itself.”

Connector and Cable Information

XLR Connectors

Pin configuration for the XLR Balanced Input and Output Connector. Refer to the diagrams for connections:

- PIN 1: Shield/Ground
- PIN 2: + Input/Output
- PIN 3: - Input/Output

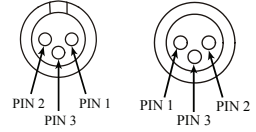

Power Control and Trigger Connectors

The C2800 Power Control Out, Trigger and PASSTHRU Output Jacks send Power On/Off Signals (+12 volt/0 volt) when connected to other Components. An additional connection is for controlling McIntosh Power Amplifiers Output Meters. A 3.5mm stereo mini phone plug is used for connection to the Power Control (Trigger) and PASSTHRU Output.

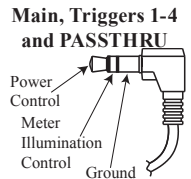

Note: The Six Foot Cables are available from the McIntosh Parts Department. Part No. 170202.

Data Port Connectors

The C2800 Data Out Ports send Remote Control Signals to Source Components. A 3.5mm stereo mini phone plug is used for connection.

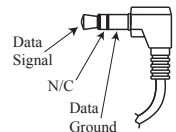

IR IN Port Connectors

The IR IN Port also uses a 3.5mm stereo mini phone plug and allows the connection of other brand IR Receivers to the C2800.

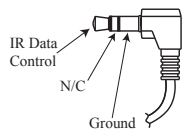

RS232 Data Port Cable

The RS232-C Data Cable is a 3.5mm stereo mini phone plug used to connect to external third party controllers.

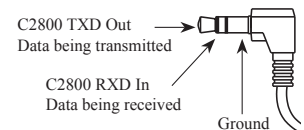

- **Electromagnetic Input Switching with Level Trim Adjustment**

Digital Logic Circuits drive Electromagnetic Switches on all Inputs and operating functions for reliable, noiseless, distortion-free switching. The Analog Inputs can be matched in level, preventing abrupt changes in volume levels.

- **Phono Inputs with Adjustable Gain**

The C2800 has two precision Phono Preamplifier Circuits. They have the ability to be configured for Moving Coil or Moving Magnet Cartridges. The close tolerance resistors and capacitors used in the RIAA Correction Equalization Circuitry provide an extremely flat frequency response.

- **Selectable Phono Cartridge Loading**

Adjustable Capacitance and Resistance Loading are available for both Moving Coil and Moving Magnet Phono Cartridges. Capacitance Loading is selectable from values of 50 picofarads to 400 picofarads. Resistance Loading is selectable from values of 25 ohms to 47,000 ohms.

- **Digital Audio Inputs**

The Digital Inputs decode PCM and DSD Signals from external sources. Coaxial, Optical and HDMI Inputs process Digital Signals up to 192kHz with 24-Bit resolution. The Digital MCT Input Circuitry directly decodes SACD/CD signals from an external Transport component. The USB Input for streaming audio processes Digital Signals up to 384kHz with 32Bit resolution, decodes up to DSD512 Digital Signals and DXD 24Bit with a sampling rate up to 384kHz.

- **Balanced Inputs**

The Balanced Inputs allow the connection of a source component using long cable lengths without a loss in sound quality.

- **Precision Tracking VOLUME Knob**

Volume levels are controlled by a Precision Balanced Digitally Controlled Attenuator System with an Encoder Rotary Control. This assures a 0.1dB tracking accuracy between channels. There are 214 individual 0.5dB volume level steps with no noise as the volume level is changed.

- **Variable Rate Volume and Balance Controls**

The C2800 Preamplifier's Volume and Balance Control Circuitry provides an ideal rate of change with control rotation.

- **Electronic Tone Controls with Bypass**

Electronic bass and treble circuitry allow volume level adjustments for low and high frequencies in precise one Decibel steps. The C2800 remembers the tone control circuitry bypass option for each input.

- **HXD[®] for Headphones**

The C2800 Headphone Crossfeed Director Circuitry (HXD[®]) improves the sound localization for Headphone Listening. HXD[™] restores the directionality component of the spatial sound stage normally heard with loudspeaker listening.

- **Alphanumeric Fluorescent Display**

The Front Panel Information Display indicates the Source Selection, Volume/Balance Levels and Setup Menu Selections. The display intensity is adjustable.

- **Vacuum Tube Phono Amplification**

The C2800 utilizes vacuum tube amplification circuitry for the phono inputs and preamplifier section. The circuits use the latest designs providing the lowest possible noise and distortion.

- **PASSTHRU Mode**

The Automatic PASSTHRU Mode allows the C2800 to become part of a Home Theater Multichannel Sound System.

- **Remote Control with External Sensor Input**

The Remote Control provides control of the C2800 operating functions and McIntosh Source Components connected to it. Enjoy your McIntosh System from another room in your home by connecting an external sensor.

- **Power Control Output and Trigger Assignment**

A Power Control connection for convenient Turn-On of McIntosh Power Amplifiers, Source Components and Accessories is included. The Power Control Trigger Outputs may be assigned to activate when a given Input/Output is selected.

- **Special Power Supply**

Fully regulated Power Supplies and a special R-Core Power Transformer ensure stable, noise-free operation even though the power line varies.

- **Glass Front Panel with LED Illumination**

The famous McIntosh Glass Front Panel is evenly Illuminated by multiple extra long life Light Emitting Diodes (LEDs) arranged with a special orientation. The pristine beauty of the C2800 will be retained for many years.

- **Bi-Amp Outputs**

Built-in Adjustable Highpass and Lowpass Outputs for bi-amping your speaker system.

Dimensions

The following dimensions can assist in determining the best location for your C2800. There is additional information on the next page pertaining to installing the C2800 into cabinets.

A Note on Placement:

It is important to keep your McIntosh unit out of direct sunlight and only use appropriate gentle cleaners because the Organic Anodize can become discolored over time.

While most products will maintain their classic dark features for their lifetime, some situations can accelerate discoloration. The most pervasive culprit is UV light, especially light directly from the sun, or high intensity spotlights. Even high intensity short-term exposure can result in discoloration.

Chemicals can also alter the finish of the Anodize. Aggressive cleaners will take their toll over time and actually etch away the Anodize finish.

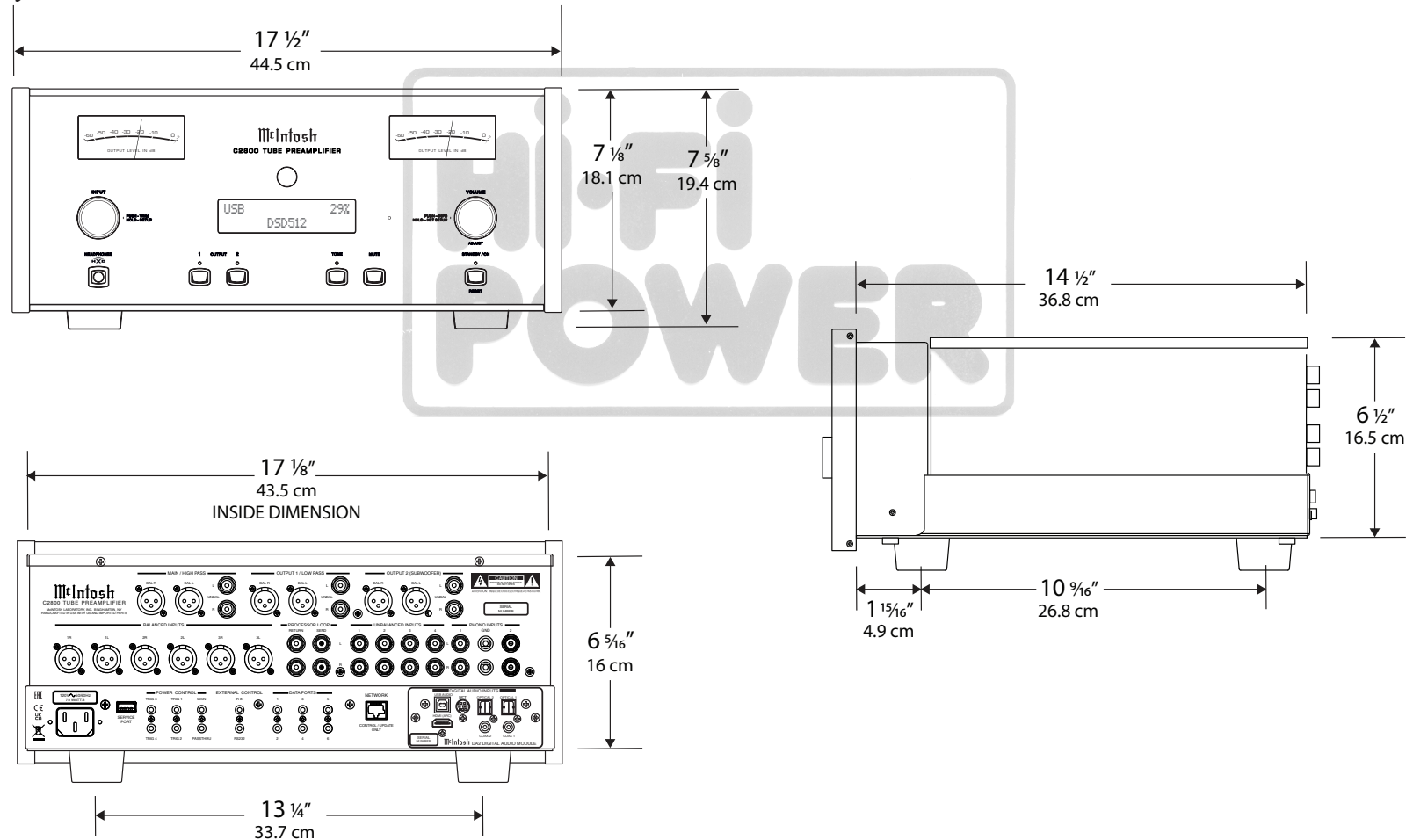

Installation

The C2800 should be installed upright on its four feet. Adequate ventilation is important and will aid in a long trouble-free life of the C2800. You must ensure proper airflow by allowing at least 3 inches (7.6cm) above the unit and 3 inches (7.6cm) for the front, rear and sides. Do not remove the feet to ensure adequate airflow beneath the C2800. There must be openings for cool air to enter (below) and warm air to escape (above) the C2800.

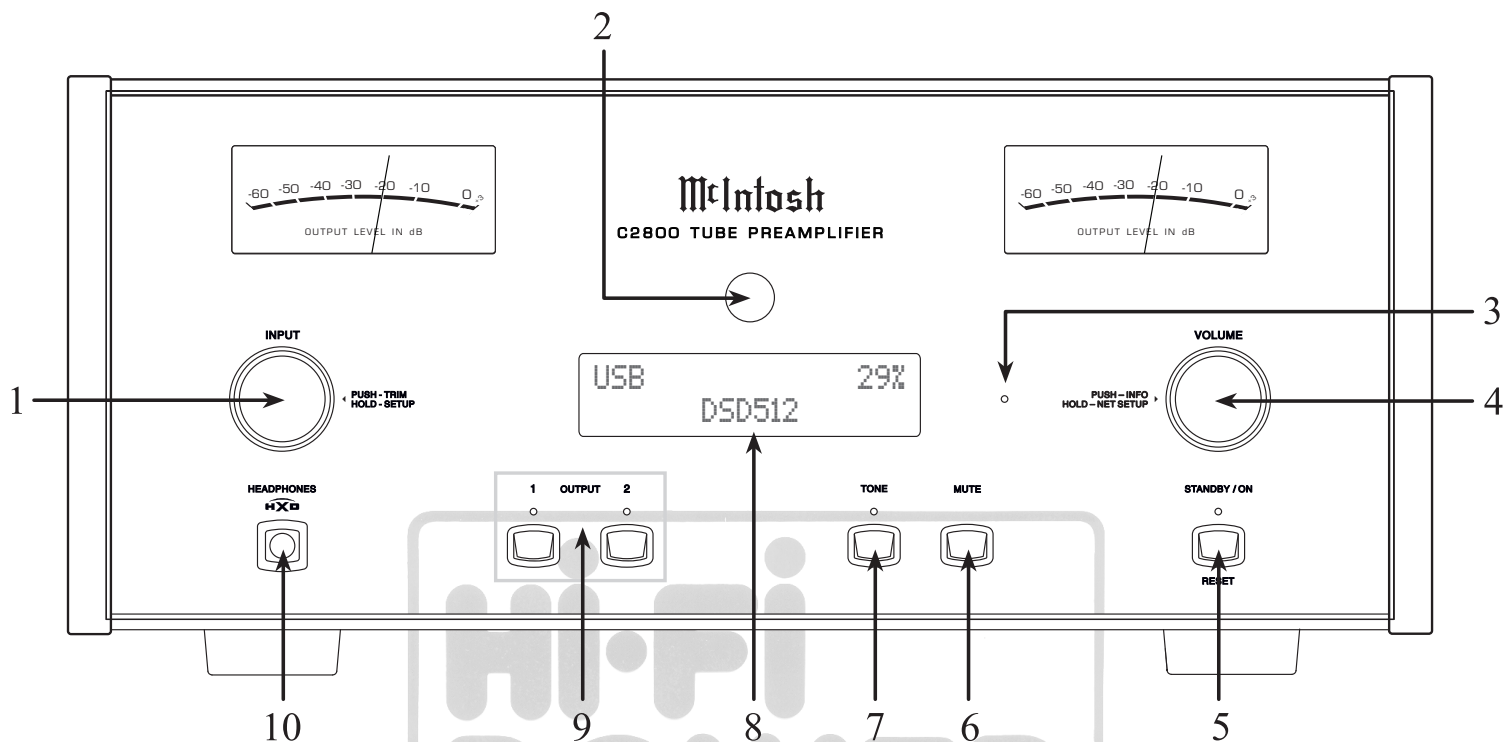

Front Panel Knobs and Buttons

1. **INPUT Knob** is used to select a source for listening and recording. The knob is also used for menu navigation.
2. **IR Sensor** receives commands from a Remote Control.
3. **Network Status LED** provides NET connection status.
4. **VOLUME Knob** allows adjustment of the listening level for both channels, Trim Mode Adjustments, and various SETUP Functions.
5. **STANDBY/ON Button** with indicator switches the C2800 ON or OFF (Standby) and resets the microprocessors.
6. **MUTE Button** mutes the audio from the loudspeakers and Headphones.
7. **TONE Button** allows the user to select whether or not the tone circuit is engaged. In the Off mode, the tone controls are bypassed and the audio signal is unaltered. In the On mode, the audio signal can be adjusted via the Trim Mode.
8. **Information Display** indicates the Sources, Volume, other Audio Settings, Operational Functions and Setup Menu Settings
9. **OUTPUT 1 and 2 Buttons** with indicators switch the Preamplifier Outputs 1 and 2 On or Off.
10. **HEADPHONES Connection** to use with low impedance dynamic headphones for private listening.

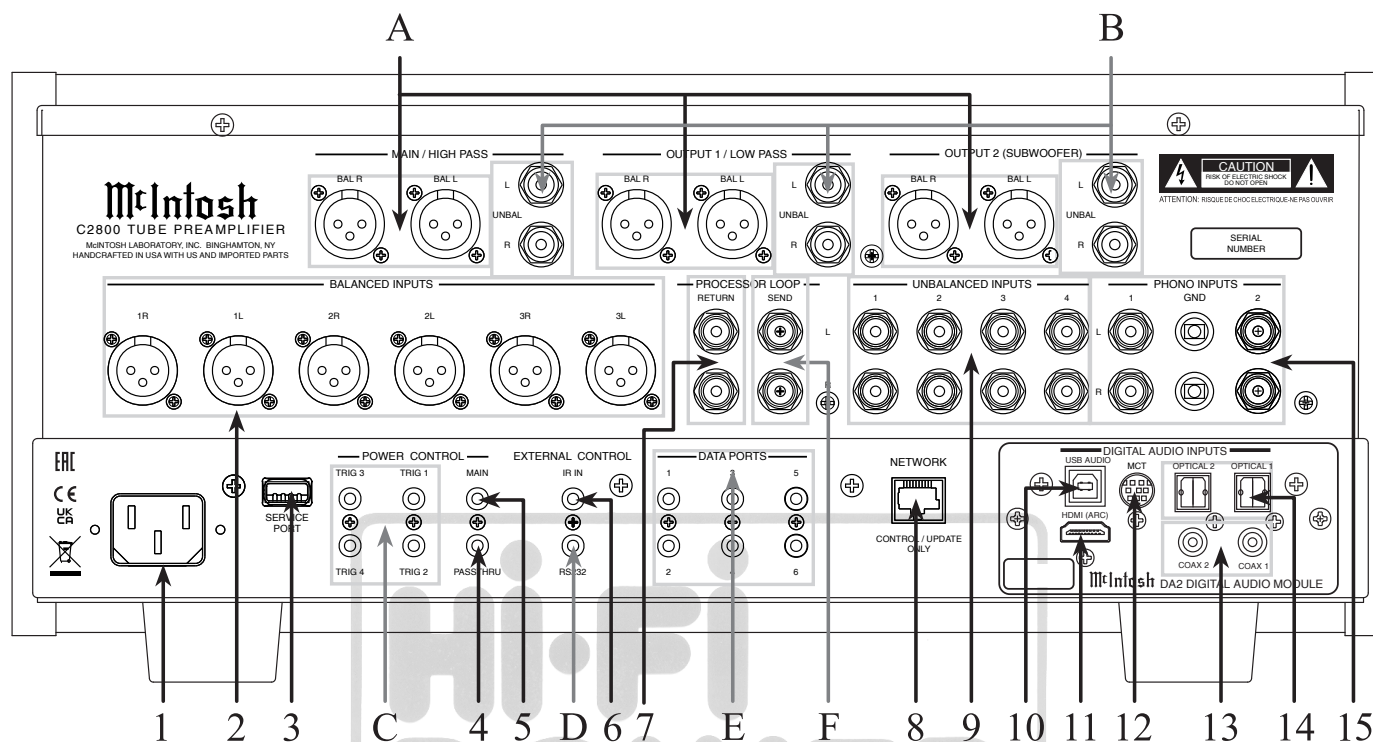

Inputs

- AC Input** uses a power cord to connect to an AC Outlet.
- BALANCED INPUTS (1 thru 3)** accept high-level program source signals.
- SERVICE USB** is a USB Type-A port used for service purposes only.
- POWER CONTROL PASSTHRU** receives On/Off signals from an Audio/Video Processor.
- POWER CONTROL MAIN** sends On/Off signals to a McIntosh Component when the C2800 Preamplifier is switched On/Off.
- IR IN** accepts an external IR receiver using a 3.5mm stereo mini phone plug cable.
- PROCESSOR LOOP RETURN** receives audio from an external equalizer or room correction processor.
- NETWORK** for a wired internet connection via ethernet.
- UNBALANCED INPUTS (1 thru 4)** accept high-level program source signals.

- USB AUDIO Input** is a USB Type-B connector used to connect the C2800 to a computer to stream digital audio.
- HDMI (ARC) Input** connects with a compatible ARC TV using an HDMI cable to share control and digital audio connectivity.
Note: The HDMI ARC functionality of the C2800 is only compatible with ARC TVs. Other devices like DVD and Blu-ray players will not work.
- MCT Input** transfers signals from McIntosh products with an MCT connector and is required for SACD audio.
- COAX Inputs (1 and 2)** accept coaxial cables for digital signals.
- OPTICAL Inputs (1 and 2)** accept optical connections for digital signals.
- PHONO Inputs (Right and Left channels)** accept signals from a Phono Cartridge.

Outputs

- BALANCED Outputs** each use an XLR connector cable for a balanced output signal.
- UNBALANCED Outputs** use an RCA connector cable for an unbalanced output signal.
- POWER CONTROL TRIG (1 thru 4)** send On/Off signals to other McIntosh components.
- RS232 Connector** communicates with external control devices using a 3.5mm stereo mini phone plug cable.
- DATA PORTS** retransmit remote control signals to source components.
- PROCESSOR LOOP SEND jack** delivers audio to an external equalizer or room correction processor.

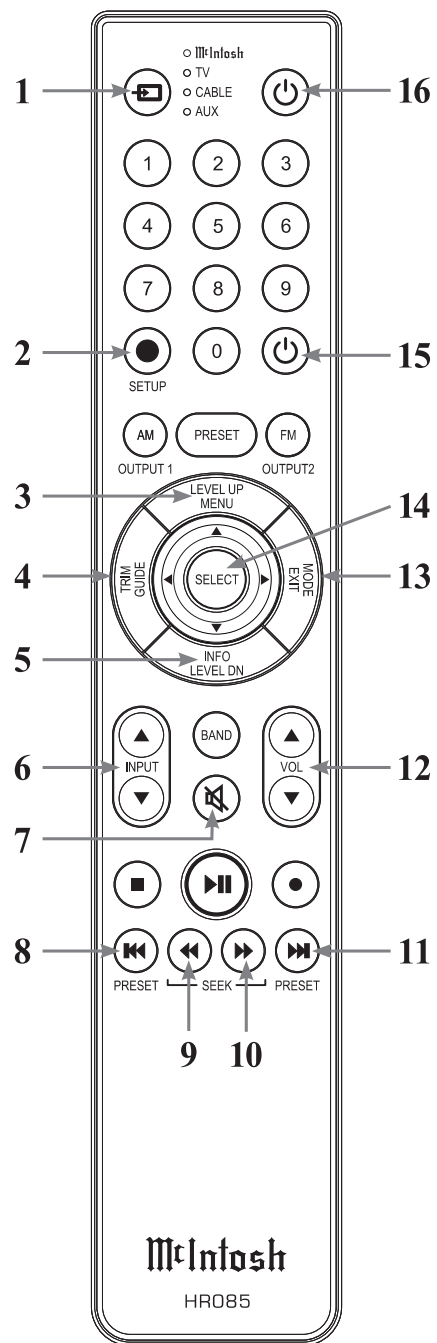

Navigating the Remote Control

- 1. Switch Device:** Select different devices for remote operation. Selected device is indicated by the LED indicator.
- 2. Setup Button:** Used to enter Setup Menu.
- 3. Level Up/Menu:** Adjusts Trim Functions settings. Accesses menu on compatible devices.
- 4. Trim/Guide:** Enters Trim Functions menu. Opens guide on compatible devices.
- 5. Info/Level Down:** Adjusts Trim Functions settings. Accesses info on compatible devices.
- 6. Input:** Changes and selects different inputs.
- 7. Mute:** Mutes audio playback.
- 8. Previous/Previous Preset:** Return to your previous media selection.
- 9. Fast Reverse/Seek Down:** Navigate backwards through the current active media using this button.
- 10. Fast Forward/Seek Up:** Navigate forward through the current active media using this button.
- 11. Next/Next Preset:** Jump to your next media selection or navigate to the next tuner preset.
- 12. Volume:** Used to adjust the volume.
- 13. Mode/Exit:** This will exit the Trim Functions menu. It will also display information or certain options.
- 14. Select:** Selects the highlighted option.
- 15. Power Off:** Turns off the selected device shown by the LED.
- 16. Power On:** Turns on the selected device shown by the LED.

Note: The HR085 Remote Control has buttons used to control multiple devices. Buttons whose function are not described are for use with other McIntosh products.

For more information, refer to the HR085 Owner's Manual on the McIntosh website at www.mcintoshlabs.com.

Remote Control Batteries

The HR085 Remote Control included with the C2800 is powered by two AAA batteries (not included). To insert or remove batteries, open the battery compartment by removing the cover located on the back of the remote control. To open, pull the clasp located just above the opening downward.

Additional Discrete Commands

Additional discrete commands for external control systems are available:

- BAL 1, 2, 3
- UNBAL 1, 2, 3, 4
- PHONO 1, 2
- COAX 1, 2
- OPT 1, 2
- USB
- MCT
- HDMI
- Power (Cycle)

These additional commands can be accessed using an optional McIntosh HR093 Service Remote Control. A list of these commands as well as Pronto Hex Codes can be found in the C2800 Pronto Hex Codes document located in the Download section of the C2800 product information at www.mcintoshlabs.com

You can also contact McIntosh Technical Assistance or your dealer for more information.

The supplied C2800 Remote Control (HR085) is capable of directly controlling the functions of contemporary McIntosh Source Components connected to the C2800 via the Data Ports.

Notes: 1. If at any time the C2800 seems unresponsive to the HR085 Remote Control Commands, press the  DEVICE Button to select **McIntosh** first.
2. For additional information on using the HR085 Remote Control with the McIntosh Model, please refer to the "How to Operate" starting on page 20.
3. For additional information on assigning the Data Ports, refer to "Data Ports" on page 13.

Trim

Press the TRIM Button until the desired Trim function (Balance, Trim Level, etc.) appears on the C2800 Front Panel Display, then press the LEVEL Up or Down Button to adjust the Trim setting.

Note: Press the TRIM Button to recall the last Trim function selected. For additional information on using the Trim Functions refer to pages 18-19.

Output Selection

Press the BLUE (Setup) Button followed by the AM (Output 1) or FM (Output 2) Button, to control the Rear Panel Audio OUTPUTS 1, 2 (ON or OFF) and Power Control TRIG 1 / TRIG 2.

Note: For additional information on assigning the Outputs (1 and 2) and Power Control Triggers (1 and 2) refer to page 3.

The supplied HR085 Remote Control is capable of directly controlling the functions of contemporary Source Components connected to the C2800 via the Data Ports.

Note: If at any time the C2800 seems unresponsive to HR085 Remote Control Commands press the  Button first.

Mute

Press the MUTE Button to mute the audio in all outputs except the SEND OUTPUT. The word MUTE will appear on the Front Panel Information Display. To un-mute the audio, press the MUTE Button again.

Disc, Server and Tape Functions

Use these buttons to operate a DVD Player, CD Player, CD Changer, Music Server or Recorder.





Numbered Buttons

Press Buttons 0 through 9 to access tuner station presets, tracks on discs or selections on a Music Server.

Disc and Track

Use the AM (disc) and FM (track) Buttons when a Disc Player or Music Server is being used.

Tuner Buttons

Press the AM or FM Button to select the desired broadcast band. Press and release the Channel Up  or Down  Button to seek the next available station. Press and hold a Channel Up  or Down  Button to seek continuously from station to station.

Volume



Press the Up  or Down  VOLUME Button to raise or lower the listening volume level.

Note: The Record Signals present at REC OUTPUTS are not affected by volume changes.

Pause

Press the Pause Button to perform various functions on a variety of McIntosh Components. It will also pause the playing of a disc or tape player.

Trim

Press the TRIM Button until the desired Trim function (Balance, Trim Level, etc.) appears on the Front Panel Information display, then press the LEVEL Up  or Down  Button to adjust the Trim setting.

Note: Press the TRIM Button to recall the last Trim Function selected. For additional information on the Trim Functions refer to pages 18 and 19.

Amplifier Selection

Press the BLUE (Setup) Button followed by the AM (Output 1) or FM (Output 2) Button, to control the rear panel Audio OUTPUTS 1, 2 (ON or OFF) and Power Control OUTPUT 1 / OUTPUT 2. These OUTPUTS provide signals to a Power Amplifier or other accessory component.

The Setup Menus are listed below.

- System
- Digital
- Inputs
- Outputs
- Triggers
- Data Out
- External Control

How to Navigate the Setup Menus

Your McIntosh C2800 has been factory configured for default operating settings that will allow immediate enjoyment of superb audio without the need for further adjustments. If you wish to make changes to the factory default settings, a Setup Menu is provided to customize the operating settings using the Front Panel Information Display.

Note: If the C2800 is currently On, proceed to step 2.

1. Press and hold in the INPUT Knob until the Front Panel Information Display indicates

```

SETUP: Menu Select
< System >
    
```

2. Rotate the INPUT Knob to select any of the available submenus.
3. To enter the selected submenu, press and hold the INPUT Knob.
4. Rotate the INPUT knob to navigate available options in the selected submenu.
5. Rotate the VOLUME knob to change the selected option's value.
6. To exit from the Setup Menu, or any of the submenus, press the INPUT Knob.

System Setup Menu

Settings	Options
Product Information	_ . _ . _
Update	Check for Update
Passthru	Off
Auto Off	Enabled , Disabled
Power Save	Enabled, Disabled
Restore Defaults	Default Settings
Factory Reset	Default Settings

Product Information

Specific identifying information for the C2800, including the System Firmware Version, can be found on the Product Information page of the System Setup Menu. This firmware effects the main circuitry and can be identified by opening the System Setup Menu. To update, see the following section.

Update

By default, the C2800 will periodically check for updates. To disable automatic updates, perform the following steps:

1. Use the INPUT Knob to enter the System Setup Menu.
2. Rotate the input until the following appears on the Information Display.

```

System: < Update >
        Automatic >
    
```

3. Rotate the VOLUME Knob to until the following appears on the Information Display.

```

System: < Update >
< Manual (Hold Input)
    
```

4. To check for a Firmware update in Manual mode, hold the INPUT Knob. After a few seconds, the Information Display will indicate that a check is being performed. If an update is found, it will be deployed immediately.
5. Exit the System Setup Menu by pressing the INPUT Knob.

System Setup Menu (continued)

Passthru

When the C2800 is part of a Home Theater or Multichannel Audio System, the Right and Left Front Channels from an Audio/Video Processor or Surround Decoder can “Passthru” the C2800 and onto its associated Power Amplifier(s). The Passthru setting allows selection of the specified C2800 Input to be used for the Right and Left Front Channels. In the example below, the Right and Left Front Channels from the Audio/Video Processor will be connected to the BALanced 2 Input Connectors on the C2800. Refer to pages 7 for additional connection information.

Note: The Phono and Digital Inputs are not assignable as a Passthru Input.

1. Use the INPUT Knob to enter the System Setup Menu.
2. Rotate the INPUT Knob until the following appears on the Information Display.

```
System: < Passthru >
         Off >
```

3. Rotate the VOLUME Knob to select “BAL 2” Input.

```
System: < Passthru >
         < BAL 2 >
```

4. Exit the System Setup Menu by pressing the INPUT Knob.

Auto Off

The C2800 incorporates an Auto Off feature, which automatically places the Preamplifier into the Standby/Off Mode. This occurs approximately 30 minutes after there has been an absence of user activity (includes changes to any of the Operation Functions such as source selection, volume adjustment, etc.) or absence of an audio signal. This feature is turned on by default but can be disabled in the System Setup Menu.

Power Save

Disabled: The network connection will remain active during standby. May also reduce wake up time.

Enabled: The network connection will be lost in standby. The unit can be turned on by IR remote control, power control, RS232, or by pressing the front panel STANDBY/ON Button.

POWER

Restore Defaults

To reset all the adjustable settings (Setup and Trim Settings) to the factory default values, perform the following steps:

1. Select the Defaults option in the System Setup Menu. The following should be on the Information Display.

```
System: < Defaults >
Hold INPUT to Reset
```

3. Press and hold in the INPUT Knob until the following appears on the Information Display, then release the INPUT Knob.

```
System: < Defaults >
In Progress!
```

```
System: < Defaults >
Completed!
```

4. Press the front panel STANDBY/ON Button to switch the C2800 on.

Factory Reset

To reset all adjustable settings and clear all network information, select Factory Reset and follow the same process as above.

Settings	Options
DA Firmware Version	
DA Update	
OPT 1 Gain	0dB to +15dB in 1dB intervals
OPT 2 Gain	0dB to +15dB in 1dB intervals
HDMI Gain	0dB to +15dB in 1dB intervals
HDMI Lip Synchronize Mode	Manual, Automatic
HDMI CEC Power	Disabled, Enabled
HDMI CEC Volume	Disabled, Enabled

DA Firmware Version

The C2800 functionality is controlled by internal software that is known as Firmware. The Firmware Number for the Digital Audio Circuitry of the C2800, and can be viewed by following the steps below:

1. Press and hold the INPUT Knob to enter the Setup Menu.
2. Rotate the INPUT Knob until the Front Panel Information Display indicates

```
SETUP: Menu Select
< Digital >
```

3. Press and hold the INPUT Knob to open the Digital Setup Menu and the Information Display will show the DA Firmware version.

DA Update

This option is for service purposes only.

Digital Gain

The C2800 offers Digital Gain Adjustments for the HDMI, OPTICAL 1 (OPT 1) and OPTICAL 2 (OPT 2) Inputs. The change in gain of a specific Digital Input, will produce a change in playback volume of the music. To change the gain for the HDMI Input perform the following steps:

1. Use the INPUT Knob to enter the Digital Setup Menu.
2. Rotate the INPUT Knob until the following appears on the Information Display.

```
Digital: < HDMI (ARC) >
+15dB
```

3. The gain can be adjusted in 1dB Gain steps by rotating the VOLUME Knob counterclockwise to reduce the gain downwards from +15 dB all the way to 0dB.
4. To adjust other Gain values, rotate the INPUT Knob to select OPT 1 or OPT 2 and the gain is adjustable in 1dB Gain steps. 0 dB is the default setting for Optical 1 and Optical 2.

```
Digital: < OPT 1 >
0 dB
```

5. The gain can be increased by rotating VOLUME Knob clockwise to increase the gain from 0 dB with an increase all the way up to +15 dB or +8dB from 0 dB.

```
Digital: < OPT 1 >
+ 15 dB
```

```
Digital: < OPT 2 >
+ 8 dB
```

HDMI (ARC) CEC Power

The C2800 HDMI Input Connector has (ARC) Audio Return Channel Circuitry, allowing the Audio Selection and Control Command of HDMI TV/Monitor Devices. By default the HDMI Input is configured to accept Power commands via CEC.

To prevent the CEC Power Control of the C2800, simply change HDMI CEC Power from On to Off.

```
Digital: < CEC Power >
< Enabled
```

```
Digital: CEC Power
Disabled >
```

HDMI (ARC) CEC Volume

To change the Consumer Electronics Control (CEC) of the volume, perform the following steps:

1. Use the INPUT Knob to enter the Digital Setup Menu.
2. Rotate the INPUT Knob until the following appears on the Information Display.

```
Digital: < CEC Volume >
< Enabled
```

3. To deactivate the Consumer Electronics Control (CEC), rotate the VOLUME Knob until the following appears on the Information Display.

```
Digital: < CEC Volume >
Disabled >
```

Digital Setup Menu (continued)

HDMI (ARC) Lip Sync Mode

The C2800 HDMI Input Connector (ARC), also has another control function. When listening and viewing a TV/Monitor HDMI Input Signal, the ARC circuitry provides a synchronized Video and Audio TV/Monitor Signal. To switch Off the AUTO Synchronised Video and Audio TV/Monitor Signal, perform the following steps:

1. Use the INPUT Knob to enter the Digital Setup Menu.
2. Rotate the INPUT Knob until the following appears on the Information Display.

```
Digital: < Lip Sync >
         < Auto
```

3. To manually configure the lip sync delay, rotate the VOLUME Knob until the following appears on the Information Display.

```
Digital: < Lip Sync >
         Manual >
```

4. The delay time can then be adjusted from the Trim Menu when the HDMI (ARC) Input is selected.

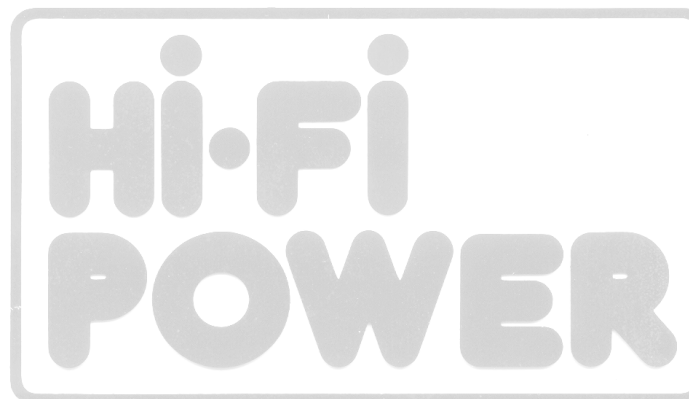

Inputs Setup Menu

Setting	Options
BAL 1-3	On/Name, Off
UNBAL 1-4	On/Name, Off
PHONO 1, 2	On/Name, Off
COAX 1, 2	On/Name, Off
OPT 1, 2	On/Name, Off
USB	On/Name, Off
MCT	On/Name, Off
HDMI(ARC)	On/Name, Off

Hold the INPUT Knob to open the Inputs Setup Menu and from there, the following changes can be made:

```
SETUP: Menu Select
       < Inputs >
```

On/Name: The selected input will be functioning as normal. Hold in the INPUT Knob to enter the menu to rename the input*.

Off: The selected input will be deactivated and will no longer be selectable from the main display during normal use. Change this setting back to “On/Name” to make it selectable again.

***Naming Inputs:** While in the selected input’s submenu, use the INPUT Knob to navigate to the input with the name you’d like to change (and turn it On using the VOLUME Knob if it isn’t already) so that the display says “Inputs: [input name] On/Name” and hold the INPUT Knob to begin renaming. The character you are currently adjusting will be blinking. Rotate the INPUT Knob to select which character you want to change and use the VOLUME Knob to change the character.

Outputs Setup Menu

The Outputs Setup Menu provides the ability to change how the C2800 Output 1, Output 2 and Headphones function.

Settings	Options
Output Mode	Switched, Unswitched, Bi-Amped (Fixed), Bi-Amped (Split)
Output Trim Level (only Output 1)	-6.0dB to +3.0dB in 0.5dB intervals
Bi-Amp Center Frequency (only Fixed Mode)	150Hz, 350Hz, 900Hz
Bi-Amp High Pass Frequency (only Split Mode)	Bypass, 50Hz, 100Hz, 250Hz
Bi-Amp Low Pass Frequency (only Split Mode)	600Hz, 1200Hz, 3000Hz
Dual Mono (Output 2)	Off, On
Headphones	Mute All Outputs, Mute No Outputs

Output Mode

The Outputs on the C2800 can be independently configured to operate in one of several modes.

- **Switched (Default)** - The Output is set to allow toggling by using the Front Panel OUTPUT 1 and 2 Buttons, or by using the OUTPUT 1 and 2 Buttons on the Remote Control.
- **Unswitched** - The Output is set to On, and toggling is disabled.
- **Bi-Amped (Fixed)** - This mode is a variant of Unswitched that is exclusive to Output 1 and enables the Bi-Amp Circuitry in Fixed Mode.
- **Bi-Amped (Split)** - This mode is the same as Bi-Amped (Fixed) but Bi-Amp Circuitry is in Split Mode.

Output Trim Level

Adjusts the level of Output 1 relative to the Main Output. This setting is always active, and is useful for bi-amping.

Bi-Amp Circuitry

The C2800 has internal, adjustable crossover. The C2800's crossover tailors the output frequency range of each amplifier section to the attached loudspeaker. In Fixed Mode, simply set the Center to the loudspeaker's Crossover Point, then frequencies above the Crossover Point will be sent to the MAIN Output and frequencies below the Crossover Point will be sent to Output 1. In Split Mode, the filter's corner frequencies can be independently configured. As an example, the High Pass Outputs could be sent to a vacuum tube amplifier, and the Low Pass Outputs could be sent to a solid-state amplifier. This adjustable crossover allows you to optimize the performance of your amplifiers to your speaker's specifications and to your listening preferences. A direct feed can also be connected to each amplifier section, thus bypassing the internal crossover.

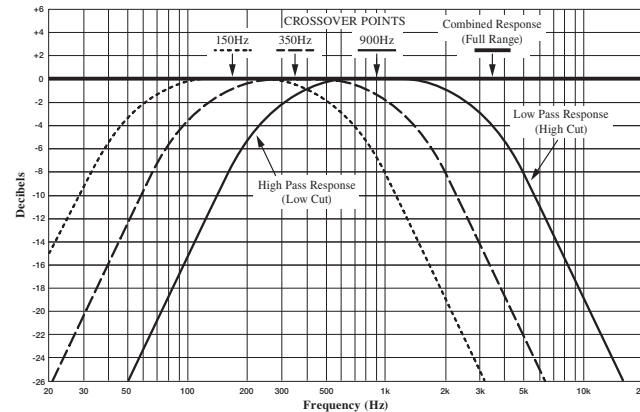

Dual Mono

Output 2 can be configured as either a stereo or mono output. These connections can feed an additional full range amplifier and speaker system, or can feed a single mono subwoofer or 2 separate Left/Right (stereo) subwoofers.

Headphones

The C2800 Default Setting for using Headphones is to automatically mute all the Output Connectors when the Headphone Cable Plug is inserted into the C2800 Front Panel HEADPHONES Jack. There are two available settings:

- Mute All Outputs
- Mute No Outputs

1. Rotate the INPUT Knob until the following appears on the Information Display.

```
Outputs: < HEADPHONES
          Mute All Outputs >
```

2. Rotate the VOLUME Knob to change the current HEADPHONES setting.

```
Outputs: < HEADPHONES
          < Mute No Outputs >
```

3. Exit the Outputs Setup Menu by pressing the INPUT Knob.

Triggers Setup Menu

The C2800 has four Power Control Triggers Connections. When the C2800 Is On, the Triggers are either activated or deactivated. Trigger 1, 2, 3 and 4 settings can be assigned to one of the available Outputs, or any combination of Inputs. These settings will control the operational power to the components connected to the various C2800 Trigger Output Connectors. Perform the following steps to setup the Trigger:

1. Use the INPUT Knob to enter the Data Out Setup Menu.
2. Rotate the INPUT Knob until the following appears on the Information Display.

```
SETUP: Menu Select
< Triggers >
```

3. Press and hold in the INPUT Knob to select the Triggers Menu.
4. Rotate the INPUT Knob to select between TRIGGER 1, TRIGGER 2, TRIGGER 3, or TRIGGER 4.
5. Rotate the VOLUME Knob to change the selected Trigger's assignment.
6. If "Input" is selected as in the image to follow, the Trigger will be configured according to the Inputs that are enable in the corresponding submenu.

```
Triggers: TRIG 1 >
< Input (Hold INPUT)
```

7. To change the Trigger's Input configuration, press and hold in the INPUT Knob.
8. Rotate the INPUT Knob to navigate the set of Inputs.

9. Rotate the VOLUME Knob to enable / disable the selected Input as in the following image.

```
Triggers: TRIG 1 >
< BAL 1 > : Off
```

10. Repeat steps 4-9 to configure any of the other Triggers.
11. Exit the Triggers Setup Menu by pressing the INPUT Knob a couple times.

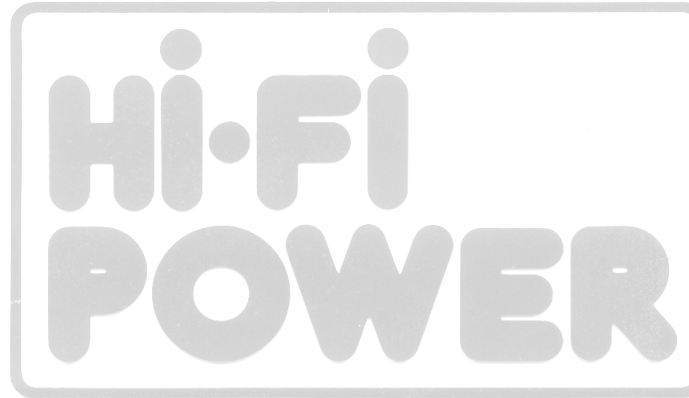

Data Out Setup Menu

Data Port Connections between the C2800 and a McIntosh Source Component allow for basic function control of the source component using the C2800 supplied HR085 Remote Control. By default, all of the four Data Ports are set to send the same Data to the selected source. To dedicate a given Data Port for only one source component (example, source component connected to the BAL 1 Input will be assigned to Data Port 1) perform the following Steps:

1. Use the INPUT Knob to enter the Data Out Setup Menu.
2. Rotate the INPUT Knob until the following appears on the Information Display.

```
SETUP: Menu Select
< Data Out >
```

3. Press and hold in the INPUT Knob until the following appears on the Display.

```
Data Out: PORT 1 >
All Data >
```

4. Rotate the VOLUME Knob to select "BAL 1" Input.

```
Data Out: PORT 1 >
< BAL 1 >
```

5. In a similar manner, perform steps 3 and 4 to assign any additional Data Ports.
6. Exit the Data Out Setup Menu by pressing the INPUT Knob.

External Control Setup Menu

Settings	Options
Front IR	Enabled, Disabled
RS232 Baud Rate	115200 Baud
IR Codes	Normal, Alternate

IR Codes

The Remote Control included with the C2800 utilizes the NORMAL McIntosh Control Codes. The Second Set of Control Codes the C2800 will respond to is referred to as the ALTERNATE Codes. The Alternate Codes are used when the C2800 is used in the same location as another McIntosh Preamplifier and/or A/V Processor. This will prevent the Remote Control from affecting the operation of both units at the same time. To activate the Remote Control ALTERNATE Codes perform the following steps:

1. Use the INPUT Knob to enter the External Control Setup Menu.
2. Rotate the INPUT Knob until the following appears on the Information Display.

```
Ext Ctrl: < IR Codes  
          < Normal
```

3. Rotate the VOLUME Knob to the Alternate Codes.

```
Ext Ctrl: < IR Codes  
          Alternate >
```

4. It is now necessary to change the HR085 Remote Control over to the Alternate Codes. Information on the HR085 Remote Control is available for download from the McIntosh website.
5. Exit the External Control Setup Menu by pressing the INPUT Knob.

Front IR

The C2800 Front Panel Sensor, which receives the signals from the HR085 Remote Control, can be switched off to prevent interference when an external IR Sensor is connected. To de-activate the Front Panel IR Sensor perform the following steps:

1. Use the INPUT Knob to enter the External Control Setup Menu.
2. Rotate the INPUT Knob until the following appears on the Information Display.

```
Ext Ctrl: Front IR >  
          < Enabled
```

3. Rotate the VOLUME Knob to select "Disabled".

```
Ext Ctrl: Front IR >  
          Disabled >
```

4. Exit the External Control Setup Menu by pressing the INPUT Knob.

RS232 Baud Rate

The C2800 may be remotely controlled from other equipment connected to the Rear Panel RS232 Jack. The speed at which the C2800 communicates (8 bit, no parity and 1 stop bit) with other equipment is adjustable from 9,600 bits per second to 115,200 bits per second. To change from the default speed of 115,200 bits per second, perform the following steps:

1. Use the INPUT Knob to enter the External Control Setup Menu.
2. Rotate the INPUT Knob until the following appears on the Information Display.

```
Ext Ctrl: < RS232 >  
          < 115200 Baud
```

3. Rotate the VOLUME Knob to select the desired Baud Rate Speed.
4. Exit the External Control Setup Menu by pressing the INPUT Knob.

System Configuration

Shown below are two typical system configurations. Your system may vary from this, however the actual components would be connected in a similar manner.

Note: The preamplifier or power amplifier may be connected to the C2800 balanced or unbalanced outputs.

Connecting Components

The C2800 has the ability to automatically switch power On/Off to Source Components via the Power Control connections. The Data Port Connections allow for the remote operation of basic functions using the C2800 Remote Control HR085. With an external sensor connected to the C2800, remote control operation of the system is possible from another room and/or when the C2800 is located in a cabinet with the doors closed.

Example 1

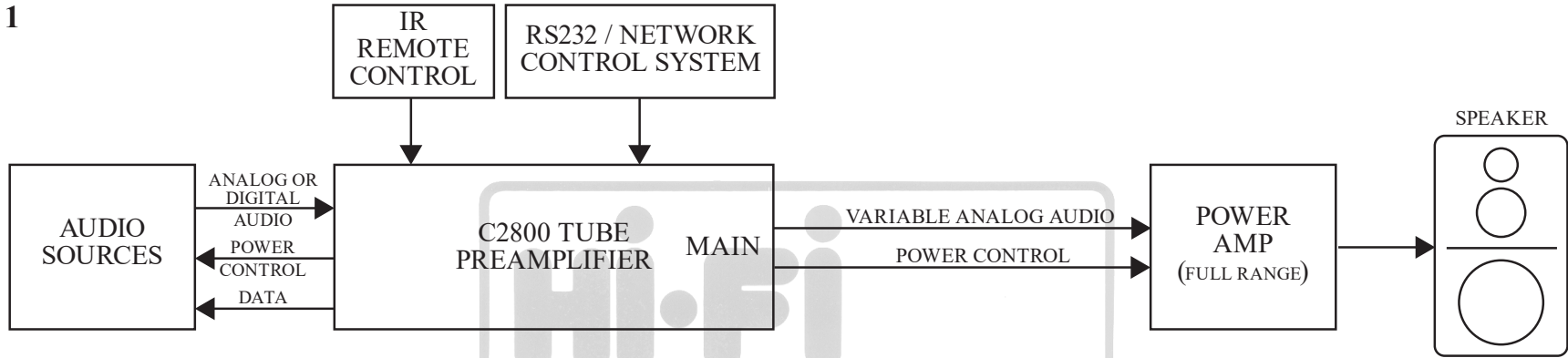

Example 2

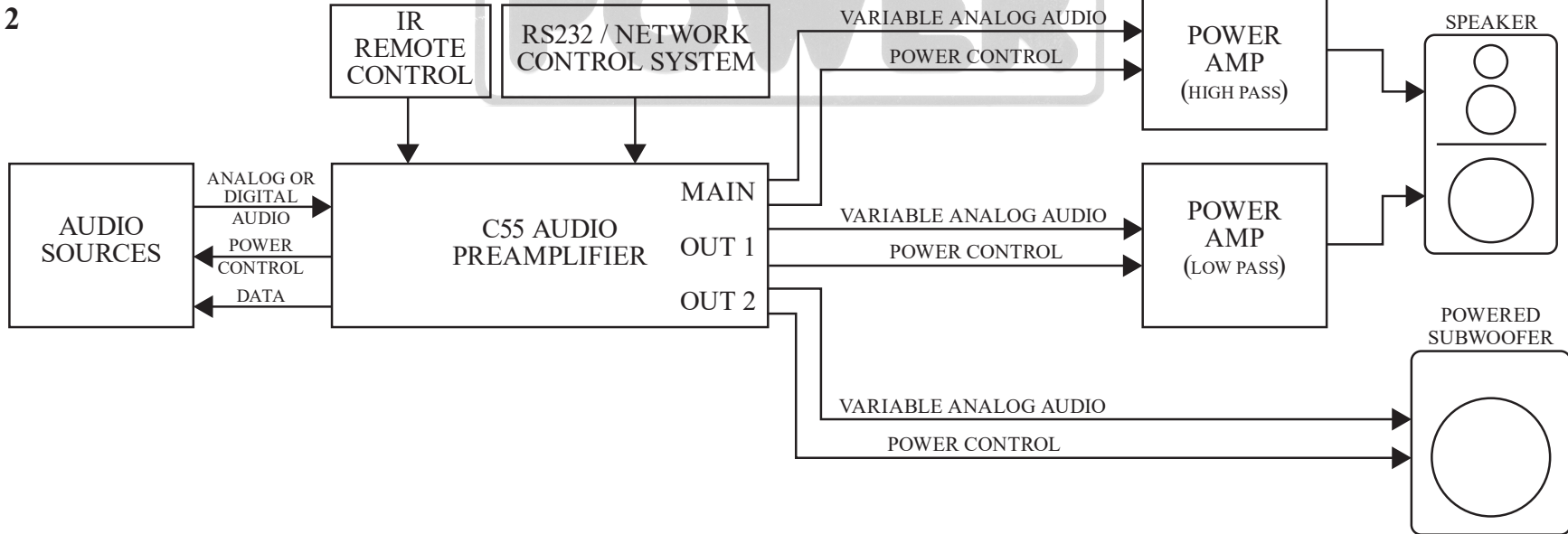

Trim Functions Menu

The Trim Settings are stored in memory independently for each Input Source Selected, except the Meter Illumination and Display Brightness settings of On or Off, which are the same for all inputs.

How to Select and Adjust Trim Functions

1. Press the Front Panel INPUT Knob to open the Trim Menu.
2. Rotate it to select the desired Trim Function.
3. Rotate the VOLUME Knob to change the setting.

Note: the Remote Control TRIM Button together with the LEVEL UP / LEVEL DN Button may also be used to access and change Trim Functions.

Approximately 5 seconds after making any changes, the Information Display will return to indicate the Source Selection and Volume Level.

Trim Functions Menu Options

Settings	Options
Balance	L, Center, R
Input Trim	-6dB to +6dB in 1dB intervals
Tone Control	On, Off
Bass	Off, -12dB to 12dB in dB intervals
Treble	Off, -12dB to 12dB in dB intervals
Mono/Stereo Mode	Stereo, Mono
Processor Loop	On, Off
Meter Lights	On, Off
Tube Lights	On, Off
Brightness	4 Levels from Dim \longrightarrow Bright
Phono Capacitance	50pF to 400pF in 50pF increments
Phono Resistance	25, 50, 100, 200, 400, 1k, 47k Ω
Phono Gain	40dB to 64dB in 6dB intervals
Lip Sync Delay	0 to 150ms in 10ms intervals
HXD Mode*	On, Off

Note: HXD Mode will only appear if headphones are plugged in.

Balance

Listening balance varies with different program sources, room acoustics and listening positions relative to the loudspeakers. Use the Balance (Trim Function) as needed to achieve approximately equal listening volume levels in each loudspeaker.

The Front Panel Display indicates the Balance changes are from 0 to 50 dB. After approximately 4 seconds the Information Display returns to indicate the Source Selection and Volume Level. To verify the Balance setting without changing it, use the TRIM Button and select Balance.

Input Trim Level

Source Components can have slightly different volume levels resulting in the need to readjust the C2800 VOLUME Knob when switching between different sources. The C2800 allows the adjustment of levels for each of the Source Inputs for the same relative volume.

Mono/Stereo Mode

By default, the Stereo Mode is active for all Input Sources however, any Input Source may be assigned to the Mono Mode of operation. To change Stereo Mode to Mono for a given Input Source, perform the same type of steps by using the Front Panel Controls or the Remote Control Pushbuttons as done for TONE CONTROL Settings:

Note: The audio signal present at the SEND FIXED OUT Jacks is affected by the Stereo/Mono setting.

Processor Loop

Connects or disconnects an external equalizer or room correction processor.

Meter Illumination

The Meter Illumination of McIntosh Power Amplifiers, when connected to the C2800, may be switched On or Off. If using non-McIntosh components see page 21.

Information Display Illumination

The brightness level of the Front Panel Information Display can be adjusted. It has 4 levels that vary from dim to bright.

Phono Adjustments

First select the Phono 1 or Phono 2 Input then press and rotate the INPUT Control to display the active type of load setting for the phono cartridge selected.

Phono Capacitance

Rotate the INPUT Control to select desired Capacitance.

The available settings are: 50pF, 100pF, 150pF, 200pF, 250pF, 300pF, 350pF, and 400pF.

Phono Resistance

Rotate the INPUT Control to select desired Resistance.

The available settings are: 25 Ω , 50 Ω , 100 Ω , 200 Ω , 400 Ω , 1K Ω , and 47k Ω .

Phono Gain

Rotate the INPUT Control to select desired Gain. The available settings are 40db, 46db, 52db, 58db, and 64db.

Trim Functions Menu (continued)

Lip Sync Delay

When the Lip Sync Mode is set to Manual, and when the HDMI Input is selected, the Trim menu will allow the HDMI Audio Lip Sync Delay to be adjusted from 0 to 150ms in 10ms intervals.

HXD Mode

When headphones are connected to the C2800 Front Panel Jack, an additional TRIM function becomes available. McIntosh's HXD brings the acoustical depth and spatiality of music normally heard with loudspeakers, to your headphones.

Note: The Headphone Output is optimized for impedances ranging from 100 to 600 ohms.

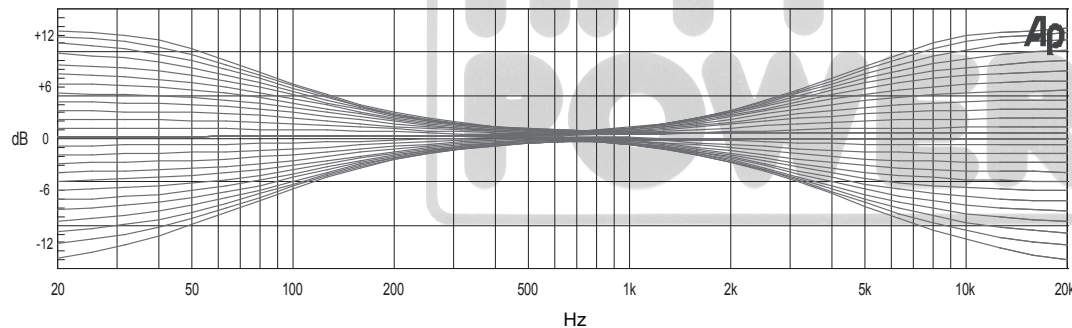

Tone Control

With the Tone Controls are On, the Treble and Bass Trim Settings may be adjusted for the currently selected input source. The TONE LED indicator will be illuminated. When the Tone Controls are Off, the previous settings for Treble and Bass are bypassed from the signal path.

Note: the audio signal present at the SEND FIXED OUT Jacks is unaffected by the TONE settings.

Bass

The intensity of the low frequencies in the music can be increased or decreased by using the Trim Select and Trim Adjust controls.

Treble

The intensity of the high frequencies in the music can be increased or decreased by using the Trim Select and Trim Adjust Control.

Network Information Menu

The Network Information Menu lists information about network connection. Press the VOLUME Knob to open the Network Information Menu. Navigate between settings using the INPUT Knob. The chart below details all of the available settings.

Settings	Options
Connection Type	Displays Connection Type
IP Address	Displays IP Address
Ethernet MAC Address	Displays Ethernet MAC Address
Wi-Fi MAC Address	Displays Wi-Fi MAC Address

McIntosh Connect App

Press and hold the VOLUME Knob to put the C2800 into Network Setup Mode. The NETWORK Status LED will blink—indicating that network settings can be configured from the McIntosh Connect App.

Note: The C2800 will exit Network Setup Mode if put into Standby.

Power On and Off

The Red LED above the STANDBY/ON Button lights to indicate the C2800 is in Standby mode. To switch ON the C2800, press the STANDBY/ON Button on the Front Panel or the  (Power - Green) Button on the Remote Control. The C2800 will go through a brief startup initialization with the Front Panel Information Display indicating the last used source and volume setting. This is followed by the volume setting indication starting at zero and then increasing to the last used volume setting.



To switch OFF the C2800 press the STANDBY/ON Button on the Front Panel or the (Power - Red) OFF Button on the Remote Control.

Note: For an explanation of the Remote Control Button functions, refer to page 8.

Source Selection

Rotate the INPUT Control to select the desired source or press the INPUT Up▲ or Down▼ Button on the Remote Control.



VOLUME Knob

Rotate the Front Panel VOLUME Knob or use the VOLUME Up▲ or Down▼ Buttons on the Remote Control for the desired listening level.

Mute

Press the MUTE Button, on the C2800 Front Panel or on the Remote Control, to Mute the Audio in all outputs (Main, Output 1, Output 2 and Headphones) except the SEND FIXED OUT. The Front Panel Information Display will indicate the Source Name and the word MUTE in place of the actual volume setting.



Pressing the Mute Button a second time or adjusting the VOLUME Knob (either the Front Panel or Remote Control) will unmute the C2800.

Output 1 and 2

Press the Front Panel OUTPUT 1 or OUTPUT 2 Button or use the Remote Control and press the SETUP/BLUE Button followed by the OUTPUT 1 or OUTPUT 2 Button, to send audio to separate Power Amplifiers connected to the rear panel OUTPUT 1 or 2 Jacks. It also activates the POWER CONTROL TRIGGER 1 or 2 Jacks on the rear panel of the C2800. To stop the Audio and Power Control Signals from going to the separate Power Amplifiers, press the same Button(s) a second time.

Passthru

Refer to Passthru Information in the C2800 Setup Section on page 14 to activate the function and select the desired Input on the C2800.

The C2800 will automatically turn On and switch to the previously setup Passthru Input when the McIntosh A/V Processor or Multichannel Surround Decoder is turned-on. The Audio Preamplifier Front Panel Alphanumeric Display will indicate "PASSTHRU".

The C2800 OUTPUT 1 and 2 are active when in the Passthru Mode. The other Front Panel Controls and Buttons are deactivated as long as the Passthru Mode is active.

Headphone Jack

Connect a pair of dynamic headphones to the Headphones Jack with a 1/4" (0.635cm) stereo phone type plug for private listening. The default setting is for all of the Power Amplifier Output Connections (1 and 2) to automatically mute.

How To Make a Recording

1. Select the desired signal source you wish to record by using the Front Panel INPUT Control or using the INPUT UP / DOWN Button on the Remote Control.
2. Adjust the record level using the recorder level control and proceed with the recording process.
3. Listen to the playback of the program source just recorded by selecting the Input Source connected to the recorder component output.

How to Operate the C2800 (continued)

Digital Inputs

When a Digital Input on the C2800 is selected, the Front Panel Information Display indicates the sample rate or audio format when a signal is present.

During the time there is no Digital Signal present the display will indicate “_____”.

MCT Input

When playing a multi-layer SACD, select the stereo (SACD) or CD layer. The multi-channel layer will not reproduce sound.

Optical

The two Optical Inputs allow digital sources to be connected to the C2800 using TOSLINK cables also known as “optical audio cables.” The optical inputs can handle high resolution digital audio up to 192kHz/24-bit. The C2800 DAC will process standard format S/PDIF PCM signals and Dolby Digital and DTS bitstreams. Unsupported formats can result in strange and/or unpleasant sounds.

Coaxial

The two Digital Coaxial Inputs allow digital sources to be connected to the C2800 using Digital Audio RCA Coaxial cables. The COAX inputs can handle high-resolution digital audio up to 192kHz/24-bit. The C2800 DAC will process standard format S/PDIF PCM signals and Dolby Digital and DTS bitstreams. Remember, unsupported formats can result in strange and/or unpleasant sounds.

HDMI ARC

The HDMI ARC (Audio Return Channel) allows you to use your entire audio system to play the sound from your TV.

- Notes:*
- Ensure you are connected to the TV’s HDMI input port that is labeled “ARC”.
 - Your TV’s setup menu and settings may need to be adjusted before sound is heard.
 - When the C2800 is set to the HDMI input, the unit will automatically turn On and Off with the TV. The front display will show “Entering HDMI Standby Mode” when turning Off.
 - Multi-channel formats will be down mixed to a 2-channel output.

Audio formats supported by HDMI ARC:

- PCM (2 channel)
- Dolby Digital (up to 5.1 channel)
- DTS Digital Surround (up to 5.1 channel)

USB Audio

The USB Audio Input of the C2800 provides the capability to receive music/sound in a digital format from a connected computer.

Software Requirements

Apple® computers with OS-10.6.8 are able to communicate with the C2800 without any installations necessary.

For Windows-based computers (PC), Windows 7 (Service Pack 1) or later is required. The correct McIntosh USB Audio driver must be installed for the PC to communicate with the C2800.

To install the McIntosh USB driver for Windows-based computers download the latest driver from the McIntosh website.

The driver can be found in the Downloads section of the webpage under Software Updates. Choose the DA2 Digital Audio Module: McIntosh USB Audio Windows Driver. You may select this driver in many third-party applications such as JRiver Media Center.

The C2800’s display will show the sampling rate or bit rate for the USB Audio Input.

Troubleshooting

Reset of Microprocessors

In the unlikely event the controls of the C2800 stop functioning, the microprocessors can be reset by performing the following:

1. Press and hold in the STANDBY/ON Button until the LED above the STANDBY/ON Button illumination is extinguished. Then release the STANDBY/ON Button.
2. To switch the C2800 back On, press the STANDBY/ON Button.

Note: This can be performed with the C2800 On or in the Standby Mode.

Meter Lights

Meter lights in Power Amps and Source units have the ability to be turned On and Off by the C2800. But sometimes if a non-McIntosh unit is used, the Meter lighting circuit is defeated and the lights are always Off.

To remedy this, place a 173419 Trigger Adapter Cable in-line with the normal 170202 Power Control cable.

This Adapter leaves the ring terminal unconnected, which allows the meter lights to remain illuminated.

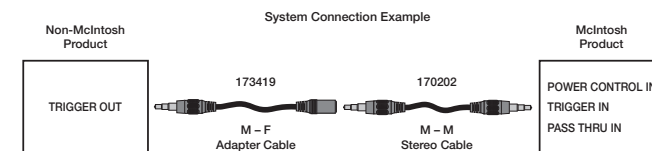

Note: all measurements with EQ filters and output filters bypassed.

Frequency Response

+0, -0.5dB from 20Hz to 20,000Hz

Total Harmonic Distortion

0.08% from 20Hz to 20,000Hz

Rated Output

2.5V Unbalanced, 5V Balanced (Main)
450mV (Fixed Output)

Maximum Voltage Output

8V RMS Unbalanced, 16V RMS Balanced

Sensitivity (for rated output)

High Level, 450mV Unbalanced, 900mV Balanced
Phono MM, 4.5mV
Phono MC, 0.45mV

Signal To Noise Ratio (A-Weighted)

High Level - 100dB (Below rated output)
MM Phono - 75dB (Below 5mV input)
MC Phono - 75dB (Below 0.5mV input)

Input Impedance

High Level 22K ohms Unbalanced
44k ohms Balanced

Phono 1, 2 (MM and MC)

25, 50, 100, 200, 400, 1k or 47k ohms
50 to 400pF in 50pF steps

Maximum Input Signal

High Level, 5V Unbalanced, 10V Balanced
Phono MM, 80mV
Phono MC, 8mV

Voltage Gain

High Level to Fixed Output: 0dB
High Level to Main Output: 15dB
Phono 1, 2 (MM and MC) Selectable 40dB, 46dB,
52dB, 58dB, or 64dB

Output Impedance

100 ohms Unbalanced
200 ohms Balanced

Headphone Load Impedance

100 ohms to 600 ohms

Digital Input Sample Rates

Coaxial: PCM -16Bit, 24Bit - 44.1kHz to 192kHz
Optical: PCM - 16Bit, 24Bit - 44.1kHz to 192kHz
USB: PCM - 16Bit, 24Bit, 32Bit - 44.1kHz to
384kHz
MCT: PCM, SACD, -16Bit, 24Bit - 44.1kHz to
192kHz
DXD - DXD352.8kHz, DXD384kHz
DSD - DSD64, DSD128, DSD256, DSD512
HDMI: PCM 24bit, 44.1kHz - 192kHz
DTS
Dolby Digital

Tube Complement

4 Tubes: 3-12AX7A and 1-12AT7

Trademarks of McIntosh Laboratory, Inc.:

The following are Registered Trademarks of McIntosh Laboratory, Inc. in multiple jurisdictions around the world: the written McIntosh logo; the McIntosh Globe logo; the Mc logo; Power Guard; Power Guard Screen Grid Sensor; Power Guard SGS; Sentry Monitor; LD/HP; Dynamic Power Manager; the 4DPM8 logo; HXD; the HDX logo; Behind The Sound; Legendary Performance.

The following are Trademarks of McIntosh Laboratory, Inc. in multiple jurisdictions around the world: Autoformer; Solid Cinch; McIntosh Monogrammed Heatsinks; Hybrid Drive; DualView; TripleView; Made of Sound.

The foregoing trademarks, registered and otherwise, are not to be used, reproduced, or registered in any way without the express written permission of McIntosh Laboratory, Inc.

Power Control and Trigger Output

12VDC, 25mA

Power Requirements

Field AC Voltage conversion of the C2800 is not possible. The C2800 is factory configured for one of the following AC Voltages:

100 Volts, 50/60Hz at 75 watts
110 Volts, 50/60Hz at 75 watts
120 Volts, 50/60Hz at 75 watts
220 Volts, 50/60Hz at 75 watts
230 Volts, 50/60Hz at 75 watts
240 Volts, 50/60Hz at 75 watts

Standby Power, less than 0.5 watts

Note: Refer to the rear panel of the C2800 for the correct voltage.

Overall Dimensions

Width is 17 1/2 inches (44.4cm)
Height is 7 5/8 inches (19.4cm) including feet
Depth is 18 inches (45.72cm) including the Front Panel, Knobs and Cables

Weight

28 pounds (12.5 kg) net, 43.5 pounds (19.7 kg) in shipping carton

Shipping Carton Dimensions

Width is 27 inches (68.6cm)
Height is 12 inches (30.5cm)
Depth is 25 inches (63.5cm)

Packing Instructions

In the event it is necessary to repack the equipment for shipment, the equipment must be packed exactly as shown below. **It is very important that the four plastic feet are attached to the bottom of the equipment. This will ensure the proper equipment location on the bottom pad. Failure to do this will result in shipping damage.**

Use the original shipping carton and interior parts only if they are all in good serviceable condition. If a shipping carton or any of the interior part(s) are needed, please call or write Customer Service Department of McIntosh Laboratory. Refer to page 2. Please see the Part List for the correct part numbers.

Parts List

Quantity	Part Number	Description
1	033888	Shipping carton only
4	034670	End cap
1	033697	Inside carton only
1	034414	Top pad (foam)
1	034576	Bottom pad
4	017937	Plastic foot
4	400159	#10-32 x 3/4" screw
4	404080	#10-7/16" Flat washer

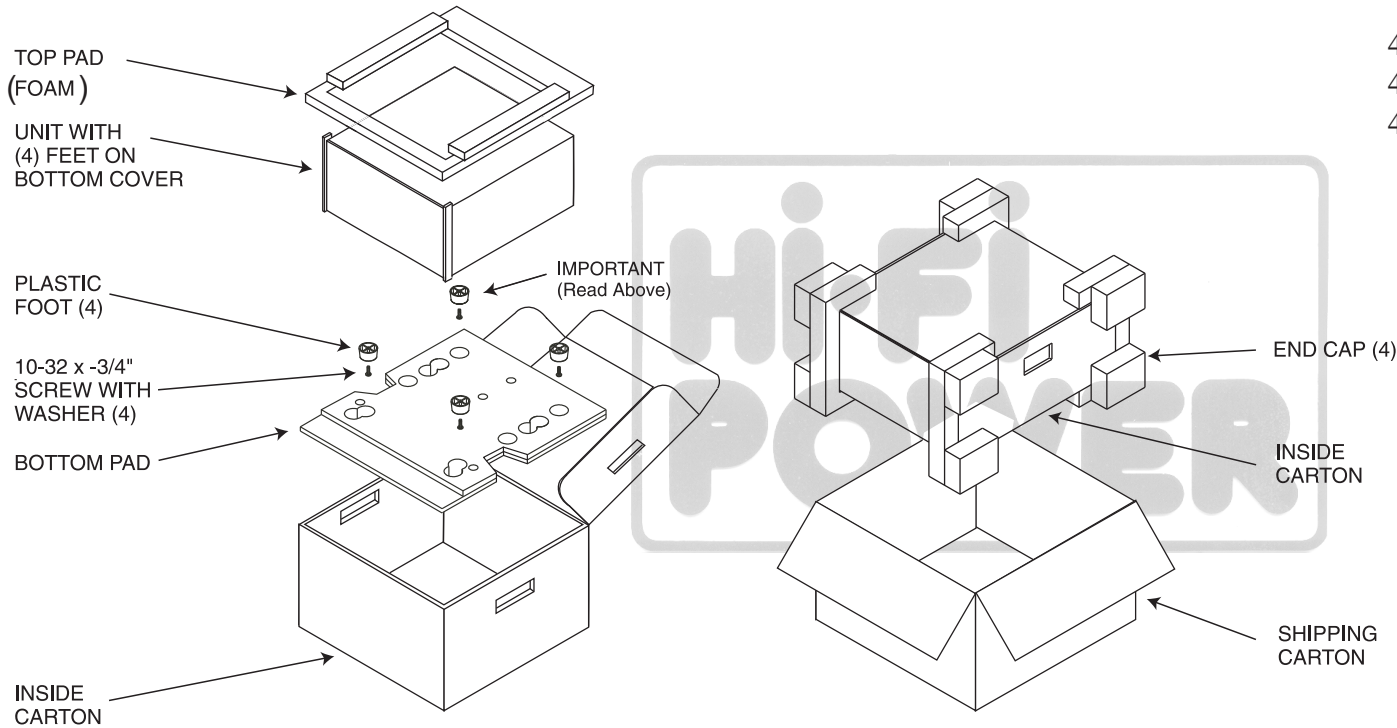



The continuous improvement of its products is the policy of McIntosh Laboratory Incorporated who reserve the right to improve design without notice. The C2800 is designed to employ non-McIntosh-provided services some of which require separate customer subscriptions and some of which do not, as part of the Product's functionality. Because McIntosh cannot control the providers of such services or the services themselves, the owner of the Product therefore assumes all risks related to the use of services provided by anyone other than McIntosh itself. McIntosh cannot and does not warrant against, and shall have no liability of any kind for any of the following that are attributable to non- McIntosh providers or services: (i) interruption, discontinuance, or other unsatisfactory performance of service; (ii) reduced Product functionality that is so attributable; or (iii) any other loss or damage of any kind that is so attributable.

Printed in the U.S.A.

© 2023 McIntosh Laboratory, Inc.

McIntosh Part No. 24124100



• MAPNH 8 AOHNA 10433 • THA. 210 3845676 - 210 3845272 FAX. 210 3809747 • e-mail: sales@hifipower.gr •