

# CARY AUDIO

## OWNER'S MANUAL

### **SLI-80HS**

Integrated Stereo Amplifier

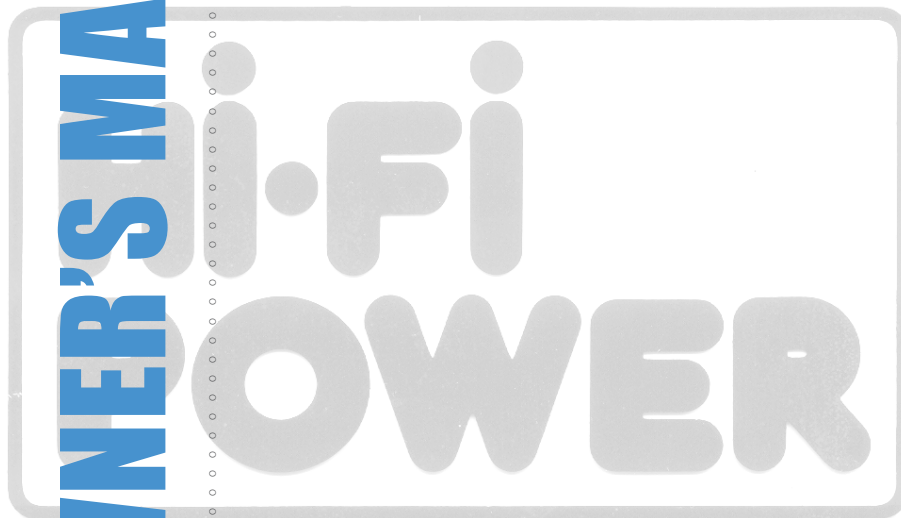

NOTE: Before installing your new component, please read this manual carefully as it will inform you of the product specifications, proper installation and correct operating procedures for your unit. Also included in this manual are guidelines on how to service and care for your new Cary Audio Design product.

# TABLE OF CONTENTS

---

<b>Important Safety Instructions</b> .....	2
<b>Welcome</b> .....	5
<b>Features</b> .....	6
<b>Specifications</b> .....	7
<b>Installation</b>	
Unpacking .....	9
Warranty Card .....	9
Placement .....	9
Power Requirements.....	9
Speaker Cables .....	9
<b>Operation</b>	
Front.....	10
Rear .....	10
Break-In Period .....	11
Bias Measurement .....	11
<b>Service and Care</b>	
Care and Cleaning .....	12
Tube Replacement .....	12
AC Power Fuse Replacement .....	12
Factory Service .....	12
Non-Warranty Repairs .....	13
<b>Troubleshooting Guide</b> .....	14
<b>Diagrams</b>	
Top Cover Installation.....	15
Bias Adjustment .....	16
Tube Placement Chart .....	17
4/8 OHM Switch Settings .....	17
Side Panel Installation .....	18
Remote Control.....	18
<b>Safety Requirements for Servicing</b> .....	19
<b>Limited Warranty</b> .....	20

# IMPORTANT SAFETY INSTRUCTIONS

The lightning flash with arrowhead, within an equilateral triangle, is intended to alert the user to the presence of uninsulated "dangerous voltage" within the product's enclosure that may be of sufficient magnitude to constitute a risk of electric shock to persons.



The exclamation point within an equilateral triangle is intended to alert the user to the presence of important operating and maintenance (servicing) instructions in the literature accompanying the appliance.

**WARNING: TO REDUCE RISK OF FIRE OR ELECTRICAL SHOCK, DO NOT EXPOSE THIS EQUIPMENT TO RAIN OR MOISTURE.**

**ATTENTION:**  
RISQUE DE CHOC ELECTRIQUE - NE PAS OUVRIR  
**NO USER-SERVICEABLE PARTS INSIDE.  
REFER SERVICING TO QUALIFIED PERSONNEL.**

**TO PREVENT THE RISK OF ELECTRIC SHOCK, DO NOT REMOVE COVER OR BACK. NO USER-SERVICEABLE PARTS INSIDE.**



Protective Earthing

Additional Safety Information specific to this product may be contained in the Owner's Manual supplied with this product



Hot Surface

## Please read these important safety instructions before operating this equipment.

1. Before powering up the equipment, read all safety and operating instructions and follow them as instructed. Retain the safety and operating instructions for future reference.
2. Do not place the unit on an unstable cart, stand, tripod, bracket, or table. The unit may fall, causing injury to a person or damage to the unit. Mount the unit according to the manufacturer's instructions with the suggested mounting accessory.
3. Mount the unit to a wall or ceiling only in the manner recommended by the manufacturer.
4. Do not use the unit near water (for example, near a swimming pool, bath tub, wash bowl, kitchen sink, or laundry tub) or in a damp environment (like a basement or outside in the rain).
5. Clean only with a dry cloth.
6. Do not push objects of any kind into the unit through openings as they could touch dangerous voltage points and short-out parts, possibly resulting in a fire or electric shock. Avoid spilling liquid of any kind on the unit. If water or any metal object (such as a paper clip, coin, or staple) accidentally falls inside the unit, disconnect it from the AC power source immediately and contact Cary Audio Design for further instructions.
7. Position the unit away from heat sources such as radiators, heat registers, stoves, or other units (including amplifiers) that produce heat.
8. This unit is not intended to be used on soft supported items (like blankets, pillows, etc.).
9. This unit is not suitable for use in locations where children are likely to be present.
10. Slots and openings in the cabinet create ventilation to protect the component from overheating. These openings on the top and bottom panels must remain unobstructed. Allow at least 6 inches (16cm) of clearance above the unit and an opening behind the unit for airflow. Do not place the unit on a bed, sofa, rug, built-in bookcase, or rack without adequate ventilation.
11. Use only those attachments recommended by the unit manufacturer, as others may cause hazards.
12. This unit requires a reliable connection to the socket/outlet with protective earthing by means of the specified power cord set.
13. As a safety feature, the unit may be equipped with a polarized alternating current line plug in which one blade is wider than the other. This plug will fit into the power outlet only one way. If you cannot insert the plug fully into the outlet, try reversing the plug. If the plug still will not fit, contact a licensed electrician to update your obsolete outlet. Do not defeat the safety purpose of the polarized plug.
14. Operate the unit only from the power source indicated on the marking label. If you are unsure of the type of power supplied to your home, consult your unit dealer or local power company.
15. Arrange power supply cords so that they do not suffer from foot traffic or pinching by items placed on or against them. Pay close attention to cords where plug enter the AC outlet and where they exit from the unit.
16. For added protection during a lightning storm or when the component is idle for long periods of time, unplug the unit from the wall outlet and disconnect the antenna or cable system. This will help protect the unit from lightning and power line surge damage.
17. Do not locate an outside antenna system in the vicinity of overhead power lines or other electric light or power circuits. When installing an outside antenna system, take extreme care to avoid touching the power lines or circuits; contact with them could be fatal.
18. Do not overload wall outlets, extension cords, or integral convenience receptacles as this increases the risk of fire or electric shock.
19. External wiring connected to terminals of this unit shall be installed by a skilled person.
20. When replacement parts are required, be sure the service technician has used replacement parts specified by the manufacturer or those having the same characteristics as the original parts. Unauthorized substitutions may result in fire, electric shock or other hazards.
21. Upon completion of any service or repairs to the unit, ask the service technician to perform safety checks to ensure the unit is in proper operating condition.



# IMPORTANT SAFETY INSTRUCTIONS

22. Before connecting a new product to your audio or home theater system, turn off all other equipment (preferably unplugging them from the AC power source). Many audio components feature automatic turn-on circuits that may activate during an installation, potentially causing damage to electronic components and/or speakers. This type of damage is not covered by product warranties, and Cary Audio specifically disclaims responsibility for any such damage.
23. The removable power cord provided with your unit was specifically designed for use with this product, but other AC cords may be used. Consult your dealer for advice on AC power cords and high quality wire in your system. 
24. The fuse is located inside the chassis and is not user serviceable. If the unit does not power up, contact an authorized service representative
25. Cables running inside walls should have the appropriate markings to indicate compliance and listing by the UL, CSA or other standards required by the UL, CSA, NEC or your local building code. Questions about cables inside of walls should be referred to a qualified custom installer, a licensed electrician, or low-voltage contractor.
26. Recording of copyrighted material for other than personal use is illegal without permission of the copyright holder.

**CAUTION:** High current. Connect to earth before connecting to supply of unit. Unplug the unit before performing any service.



Unit can be hot. Be careful of burned fingers when handling parts. Wait one half hour after switching off to handle parts.



**NOTE TO CATV SYSTEM INSTALLER:** This reminder is provided to call the CATV system installer's attention to article 820-40 of the NEC, ANSI/NFPA 70, which provides guidelines for proper grounding and, in particular, specifies that the cable ground shall be connected to the grounding system of the building as close to the point of cable entry as practical.

## FCC INFORMATION FOR USER:

- **CAUTION:** Any changes or modifications not expressly approved by Cary Audio Design could void the user's authority to operate the equipment.
- **NOTE:** This equipment has been tested and found to comply with the limits for a Class B digital device pursuant to Part 15 of the FCC Rules.
- These limits are designed to provide reasonable protection against harmful interference in a residential installation. This equipment generates and can radiate radio frequency energy, and if not installed and used in accordance with the instructions it may cause harmful interference to radio communications. However, there is no guarantee that interference will not occur in a particular installation. If this equipment does cause harmful interference to radio or television reception, which can be determined by turning the equipment off and on, the user is encouraged to try to correct the interference by one or more of the following measures:
  - Reorient or relocate the receiving antenna.
  - Connect the equipment into an outlet on a circuit different from where the receiver is connected.



## OUTDOOR ANTENNA INSTALLATION/SAFE ANTENNA AND CABLE CONNECTION:

- If an outside antenna or cable system is connected to the equipment, be sure the antenna or cable system is grounded in order to provide protection against built-up static charges and voltage surges. Article 810 of the National Electrical Code, ANSI/NFPA 70 (in Canada, Part 1 of the Canadian Electrical Code) provides information regarding proper grounding of the mast and supporting structure, grounding of the lead-in wire to an antenna discharge unit, size of grounding conductors, location of antenna discharge unit, connection to grounding electrodes and requirements for the grounding electrode.
- Outside antenna system should be located well away from power lines, electric light or power circuits and where it will never come into contact with these power sources if it should happen to fall. When installing an outside antenna, extreme care should be taken to avoid touching power lines, circuits or other power sources as this could be fatal. Because of the hazards involved, antenna installation should be left to a professional.

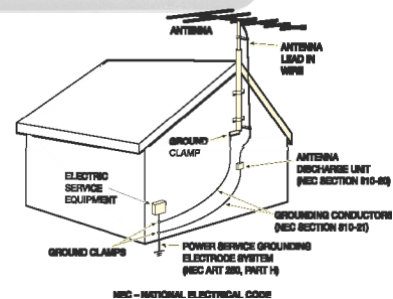

# IMPORTANT SAFETY INSTRUCTIONS

---

## Disposal Instructions

### **NORTH AMERICAN WASTE OF ELECTRICAL AND ELECTRONIC EQUIPMENT DIRECTIVE**

When discarding the unit, comply with local rules or regulations. Batteries should never be thrown away or incinerated but disposed of in accordance with the local regulations concerning battery disposal.



### **EUROPEAN UNION (EU) WASTE OF ELECTRICAL AND ELECTRONIC EQUIPMENT (WEEE) DIRECTIVE**

The European Union's WEEE directive requires that products sold into EU countries must have the crossed out trashbin label on the product (or the package in some cases). As defined by the WEEE directive, this cross-out trashbin label means that customers and end-users in EU countries should not dispose of electronic and electrical equipment or accessories in household waste. Customers or end-users in EU countries should contact their local equipment supplier representative or service centre for information about the waste collection system in the country.

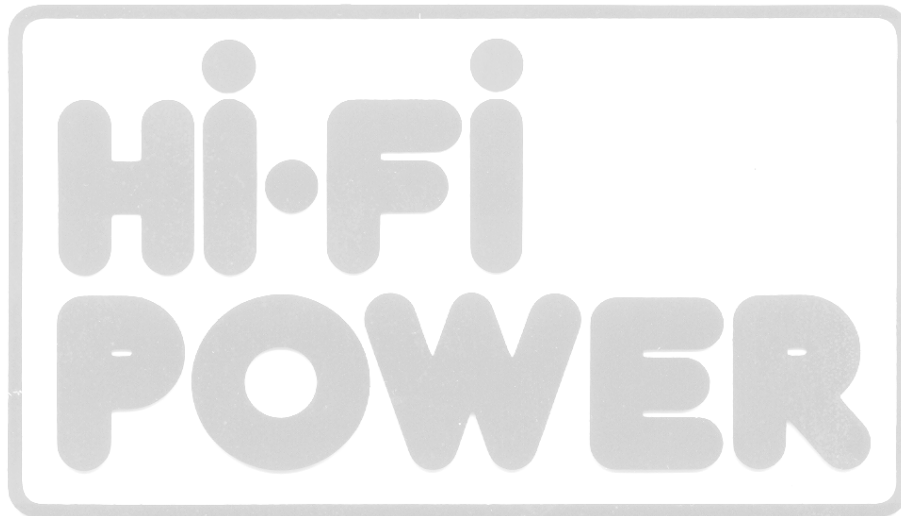

# WELCOME

---

## THANK YOU

Cary Audio would like to thank you for purchasing our products.

Since its founding in 1989, Cary Audio has stayed at the forefront of home entertainment equipment by stubbornly adhering to the principles of quality and musicality upon which it was founded. It's not enough just to be able to build great sounding gear, but it needs to be well-made, reliable, and maintain its performance and value for many years. Cary Audio has certain criteria that have guided us since we began and are still our primary focus.

We firmly believe in high performance products that offer incredible value for the money, backed by superior engineering and design, and supported by exceptional customer service. Whether a headphone amplifier or a world-class network audio player, Cary Audio uses the highest quality components available within the audio circuit, resulting in extraordinary sound quality. This is a well-known hallmark of all Cary Audio products.

For more than a quarter of a century, Cary Audio has provided the best in high performance music systems. We remain committed to our goals of building the very best products, at real-world prices, and supporting them with world-class service. Let our passion for the very finest sound help you better enjoy your music! Thank you for your continued support!

The Cary Audio Team

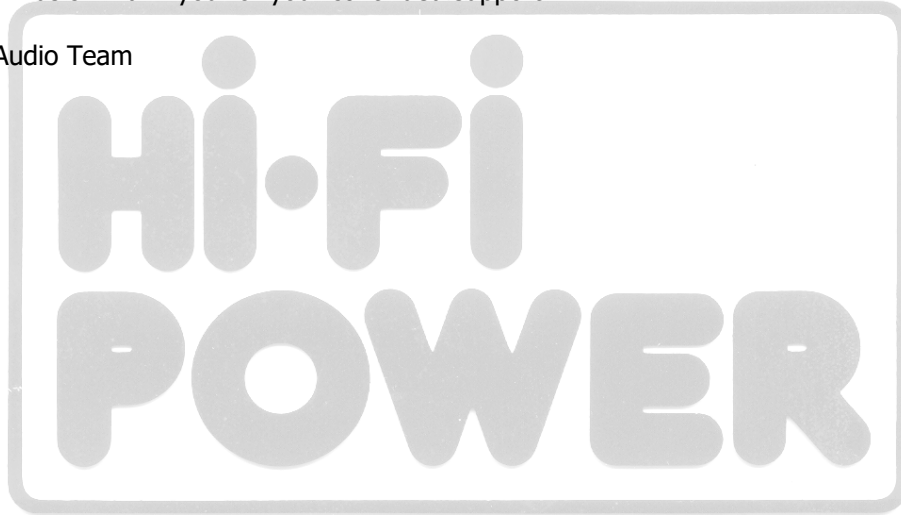



# FEATURES

---

## PRODUCT FEATURES

The SLI-80HS is one of the most exotic integrated stereo audio amplifiers available. Within its power range, the SLI-80HS displays the operating characteristics of a true "high-end" amplifier. Careful design, parts selection and proper circuit topologies contribute to incredible reliability and enjoyment.

The SLI-80HS integrated stereo amplifier operates in a Class AB1 mode utilizing a negative fixed bias supply. The KT88 output tubes are configured in push-pull and yield 40 watts/channel in triode mode and 80 watts/channel in ultra-linear mode of output power.

The output transformers in the SLI-80HS are the most important component in the amplifier and have been specifically designed by Cary Audio for use in the SLI-80HS. Negative feedback is derived from the 8 ohm tap on the output transformer secondary. This feedback circuitry is used to reduce the noise floor and improve the speaker damping characteristics. Only 4 dB of feedback is utilized. The phase inverter is a self-balancing split load configuration utilizing the 6SN7 octal base dual triode. The preamplifier circuit is a Series Regulated Push-Pull (SRPP) Class A triode voltage amplification stage direct coupled to the phase inverter. The power supply in the SLI-80HS features a 200% duty cycle EI laminate power transformer.

The input signal from the volume control is direct coupled (DC) to the first grid of the 6922. There are no coupling capacitors in line with the input signal on the SLI-80HS. The sub-woofer output is derived from the wiper of the volume control.

A great deal of attention during design of the SLI-80HS was concentrated on the "overload recovery" ability of the amplifier. The ability of an amplifier to instantly recover from clipping is much more important than is commonly believed. In the power war of amplifier manufacturers, the mentality is focused on high and then even higher power output to solve the clipping problem. When in reality, the most critical aspect is how fast a recovery an amplifier can achieve after overload. Most of the music being listened to in an average listening room is only requiring about 3 watts of power. It is on the transients of loud low frequency program material that tremendous signal voltages will appear at the input of the amplifier. It is in this situation that the overload recovery ability of an amplifier is of critical concern. The SLI-80HS will overload symmetrically at any frequency in the audio band-pass. The SLI-80HS will also yield faithful reproduction of extremely low frequencies at full output levels. Power transformer, power supply regulation, and output transformer design and careful shaping of the overall frequency response curve all play a very important part in the ability of the SLI-80HS to recover quickly when overloaded. The high voltage rail will fluctuate no more than a volt between soft and loud passages.

Another feature of the SLI-80HS, aside from how compact and gorgeous it looks, is the delightful, sensual beauty of the music it recreates. The first thing that will strike you about the SLI-80HS integrated amplifier is the incredible transparency and resolution of detail in the music. The SLI-80HS's sensual nature is best revealed in the sense of life it displays in female vocalists. The SLI-80HS integrated amplifier presents music with such presence and directness, you'll be drawn into the music hour after musically satisfying hour. This is the result of circuit techniques, which eliminate any discernible crossover notch at low levels, and also contributes to the freedom from listening fatigue. The SLI-80HS will draw you in even further as you realize how lucid and utterly uncolored neutrality reveals delicate nuances in the sound stage.

# SPECIFICATIONS

This section describes the basic specifications of the SLI-80HS at the time of printing. Specifications are subject to change without notice or obligation. When the following cautionary terms are used in this manual, these definitions apply:

## WARNING

- **Electrical hazard! Misuse or failure to follow instructions properly may result in personal injury or death!**

## CAUTION

- **No risk or personal injury; however, misuse or failure to follow instructions may result in damage to equipment.**

## NOTE

- **No risk of personal injury or equipment damage; however, misuse or failure to follow instructions may prevent proper performance of the equipment.**

<b>CIRCUIT TYPE</b>	Push-Pull Ultra-linear Amplification in Pure Class AB1
<b>POWER OUTPUT</b>	40 watts/channel – Triode 80 watts/channel – Ultra-Linear
<b>TUBE COMPLEMENT</b>	2 - 6922 Input Buffer Preamp 2 - 6SN7 Pre-Driver/Phase Inverter 4 – KT88 Output Tubes (or 6550, EL34, 6CA7, KT77, KT90, KT120)
<b>INPUT SENSITIVITY</b>	.45 volts for full output
<b>INPUT IMPEDANCE</b>	100,000 ohms
<b>NOISE AND HUM</b>	82db below rated output
<b>FREQUENCY RESPONSE</b>	19Hz to 23Khz +/- .5db at full power output
<b>OUTPUT TAPS</b>	8 Ohms, 4 Ohms
<b>MAXIMUM GAIN</b>	34dB
<b>POWER CONSUMPTION</b>	166 watts - Operation 83 watts - Standby
<b>INPUTS</b>	3 Pairs Single-ended RCA
<b>OUTPUTS</b>	1 Pair Speaker Posts (Switch for 4 and 8 Ohm Selectable) 1 Pair RCA for Subwoofer, ¼" Headphone
<b>OUTPUT POLARITY</b>	Non-Inverting (any input)
<b>WARM-UP TIME</b>	Approximately 3 minutes
<b>BREAK-IN PERIOD</b>	100 hours of music playing time
<b>FINISH</b>	Black Powder Coated Matte Chassis with Silver or Black Aluminum Faceplate and Knobs.



# SPECIFICATIONS

---

---

**DIMENSIONS** 7" H x 17" W x 16" D

---

**WEIGHT** 42 lbs.

---

---

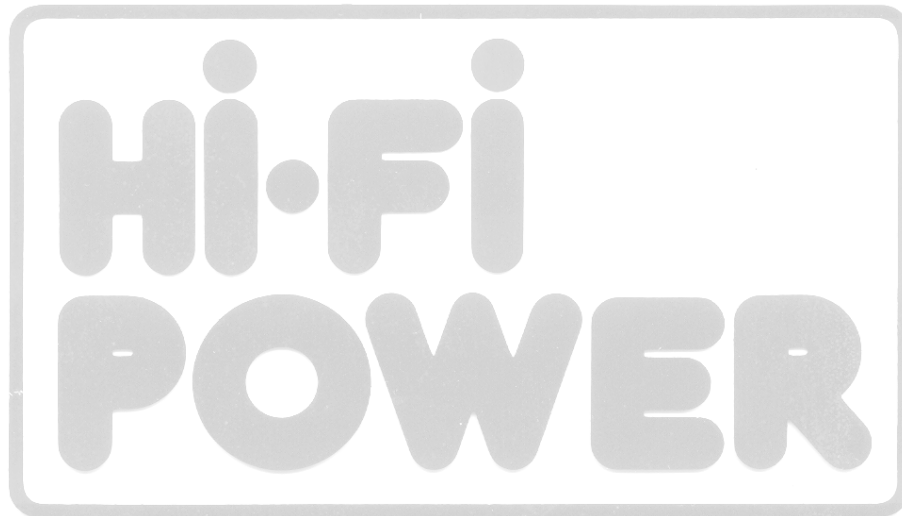

# INSTALLATION

---

This section describes the unpacking and installation procedures for your new component.

## UNPACKING

All Cary Audio Design shipping containers have been specially designed to protect their contents and special care has been taken to prevent damage under normal shipping conditions. Mishandling should be evident upon inspection of the shipping container. If shipping damage is found after visual inspection, take care not to destroy the evidence. If necessary, document the damage with photographs and contact the transport carrier immediately.

Carefully remove your new component from its packing carton and examine it closely for signs of shipping damage. We strongly recommend saving all original packing cartons to protect your amplifier from damage should you wish to store it or ship it for after-sales service.

## WARRANTY CARD

**IN THE USA AND CANADA:** If you are the original purchaser of a new unit purchased from an authorized Cary Audio dealer or from CaryDirect.com, please fill out the enclosed warranty registration card and return it to Cary Audio within 15 days of your purchase. Cary Audio also suggests that you keep your original packing cartons in case you ever need to ship the unit. Warranty restrictions apply. Consult the warranty section at the end of this manual for details. Please be certain to keep a copy of the original sales receipt from your direct purchase from Cary Audio or your authorized Cary Audio dealer to validate the warranty if ever needed. The warranty is for the original purchaser only and does not transfer to any subsequent owner.

**OUTSIDE THE USA AND CANADA:** Your local authorized Cary Audio distributor will make his own warranty policy for your country. Please check with them for the terms of warranty for your new amplifier.

## PLACEMENT

In general, the location of your new SLI-80HS is not critical. Certain precautions must be taken to ensure optimum performance. Avoid extremely hot locations such as near radiators or other heating units. Keep the top of the SLI-80HS clear of books, paper or other equipment to protect against overheating! DO NOT place your SLI-80HS in a closed bookcase - overheating will damage the amplifier! Allow 8 to 10 inches above the unit for proper ventilation.

## POWER REQUIREMENTS

The SLI-80HS is designed to operate from house current mains. The design voltage is 120/240 volts AC at 50/60Hz.

## SPEAKER CABLES

The speaker cables from the output posts of the SLI-80HS to the speaker system can be any convenient length your set-up requires. Select speaker cables of sufficient size to preserve the outstanding performance capabilities of your SLI-80HS. Heavy gauge #16 wire is suitable for distances up to 10 feet; #12 for 25 feet. Most audio dealers will have proper speaker cable in stock for this purpose.

# OPERATION

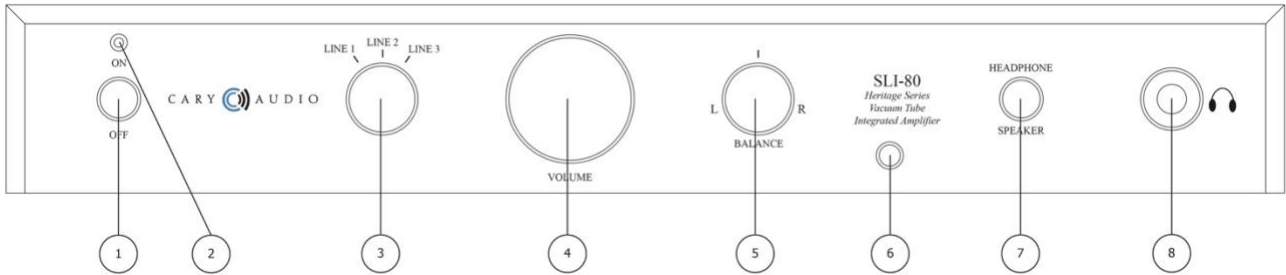

1. **Power Switch** – toggle switch in (on position) turns on AC mains and high voltage. Please make sure volume control is turned all the way down prior to turning the unit on or off.
2. **LED** – When lit indicates high voltage is (on).
3. **Input Selector** – Selection of (3) line level inputs for listening: Line 1, Line 2, and Line 3.
4. **Volume Control** – Use to increase and decrease volume by hand or IR remote.
5. **Balance Control** – Use to control the stereo balance to either the left or right side. Leave in center position for center balance.
6. **IR Sensor** – For hand held remote to control volume and mute functions.
7. **Headphone Selector Switch** – When toggle switch is set to “headphone,” sound will be redirected to output through the headphone jack. In this position, no sound will be outputted to the connected speakers. Make this selection based on which output you want to use. If you are using headphones, it would be best to have the headphones installed before switching to headphones. If the music is playing loud and you switch to headphones without headphones in place, it may damage the unit.
8. **Headphone Jack** – Accepts ¼” headphone jack. Make sure to insert all the way.

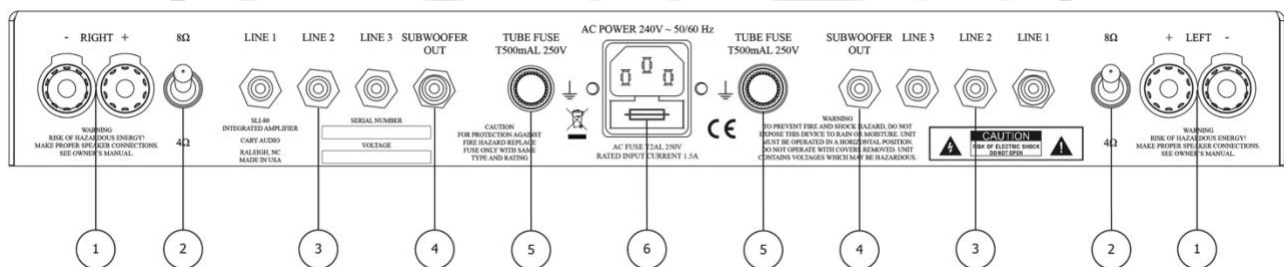

1. **Right & Left Speaker Posts** – Positive and negative 5 way binding posts. Connect Red to positive speaker terminal and Black to negative speaker terminal.
2. **8/4 Ohm** - Select the proper impedance that is called for in your speaker specification. Make sure that both left and right channels are the same. An improper setting may not yield peak performance. Listen carefully to each setting and choose the setting that matches your speakers best.
3. **1 thru 3 Right and Left RCA Line Level Inputs** – Connect line level sources to the corresponding right and left inputs of SLI-80HS.

## OPERATION

---

4. **Subwoofer Output** – Full range right and left channel output for connecting a powered subwoofer. May also be used to connect to an additional amplifier.
5. **Right & Left Channel Tube Fuse** – If no audio output and output tubes do not light up, check this fuse for replacement. The replacement tube fuse is a ½ amp fast blow large fuse.
6. **Power Cord Connection** – Plug power cord into this connection, then into your AC socket.

### BREAK-IN PERIOD

The tubes, capacitors and output transformers take approximately 100 hours of music playing to fully settle in for peak performance. The SLI-80HS will sound good from the start and after the first couple of hours you will notice increased depth and tighter bass. This break-in period defies all engineering theory but is true with high performance vacuum tube audio amplifiers.

### BIAS MEASUREMENT

The bias is factory preset. It is a good idea to measure it during the initial setup to make sure it is set to the specifications provided at the end of this manual. The AC voltage may be different from one area to the next. Follow the instructions provided. You will need a meter that allows you to read up to 100mA.

#### WARNING

- **MAKE SURE AMPLIFIER IS UNPLUGGED FROM AC MAINS BEFORE SERVICING.**

# SERVICE AND CARE

---

## CARE AND CLEANING

The cabinet housing and front panel of the SLI-80HS may be cleaned with a soft cloth and Windex or a window cleaner. The frequency of cleaning will be governed by how many hours the SLI-80HS is operated and by operating environment cleanliness.

**CAUTION:**

- Do not let any liquids spill into the vents on top of the unit.

## TUBE REPLACEMENT

If it becomes necessary to replace the tubes in the SLI-80HS amplifier, a matched quartet set of output tubes of the same brand should be used. A new tube kit is available from Cary Audio Design. You should get a few years or more from the output tubes with everyday usage and many, many years of use from the 6922 & 6SN7 input tubes.

## AC POWER FUSE REPLACEMENT

**WARNING:** When replacing the power fuse, make sure the unit is NOT PLUGGED IN.

The value for the AC fuse in US or non-US countries that support AC voltages from 100V-120V is 3A 250V slow blow fuse.

In countries that support AC voltages from 220V-240V, the AC fuse should be replaced with a 2A 250V slow blow fuse.

The AC fuse is located on the rear panel of the chassis below the AC inlet.

## FACTORY SERVICE

Careful consideration has been given to the design of your SLI-80HS to keep maintenance problems to a minimum. Any problems or requests for service should be referred to our Customer Service Department at 919-355-0010. DO NOT return the SLI-80HS to the factory without a Return Merchandise Authorization (RMA) number from our online Customer Service Center ([www.caryaudio.com](http://www.caryaudio.com)).

Cary Audio will assume no responsibility if the shipping company refuses to pay for damage due to your improper packing or lack of insurance should the unit be lost or damaged in shipment. Please retain and always use the original shipping carton for shipping the player. Also, Cary Audio reserves the right to return products sent in for service in a new box set at the customer's expense if the original packing material was damaged in the initial shipment, or if it is deemed unsatisfactory to use in return shipping.

# SERVICE AND CARE

---

## NON-WARRANTY REPAIRS

Cary Audio will provide repair service for its products charging on a time and expense basis. At this time, the standard non-warranty service bench fee is \$125 for the first hour and \$95 per hour thereafter. Parts used for repairs as well as return shipping are additional. This may change and is not a quote for service. Please call us at 919-355-0010 for more information about out-of-warranty service and repair fees.

### WARNINGS

- **MAKE NO ATTEMPT TO PUT THE SLI-80HS IN SERVICE WITH THE BOTTOM PLATE REMOVED. CONTACT WITH HIGH VOLTAGES FOUND IN THE UNIT CAN BE FATAL. COMPLETELY REMOVE AC POWER PLUG FROM THE WALL AND ALLOW 30 MINUTES FOR THE HIGH VOLTAGE CAPACITORS TO DISCHARGE THROUGH BLEEDER RESISTORS BEFORE ATTEMPTING TO CHANGE TUBES OR CLEAN THE INSIDE OF THE AMPLIFIER**

### CAUTIONS

- **NEVER REMOVE / INSERT AC PLUG WHEN THE UNIT IS ON OR THE AC POWER SWITCH IS IN THE ON POSITION. OBSTRUCTION OF THE TOP PORTION OF THE SLI-80HS WILL RESULT IN TUBES OVERHEATING AND DAMAGE TO THE AMPLIFIER**

**HI-FI  
POWER**



# TROUBLESHOOTING GUIDE

---

SYMPTOM	CAUSE	REMEDY
Hum or "Buzzing" through speakers	Ground Loop	Install 2-pin adapter on A.C. cord to float the Ground
	Intermittent or poor connection of interconnect ground	Replace interconnect
"Popping or Spitting" noise	Noisy tube	<p>If noise is in one channel, through the speaker swap one section of tubes at a time until the noise swaps channels. Replace noisy tube.</p> <p>Check bias of output tubes. If high or fluctuating rapidly, replace output tube. <i>(See Bias Adjustment)</i></p>
AC fuse blows	Line voltage surge	Replace fuse
Tube fuse blows	Shorted output tube	Replace tube and tube fuse

HI-FI  
POWER

# DIAGRAMS

## Top Cover Installation

1. [If necessary] Remove screws from locations A, B, C, & D as located in fig 1.1 using the provided allen wrench.
2. Take note of the corresponding holes on the top cover (figure 1.2) and align them with the screw holes on the SLI-80 chassis, as shown in the figure 1.3.
3. Using the provided screws and allen wrench, tighten the screws until the top cover is securely fastened to the SLI-80 chassis.

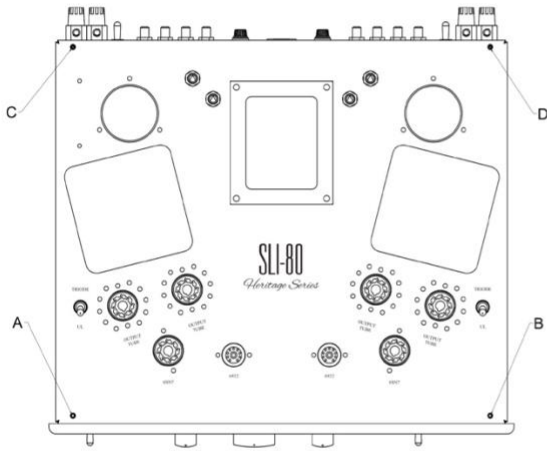
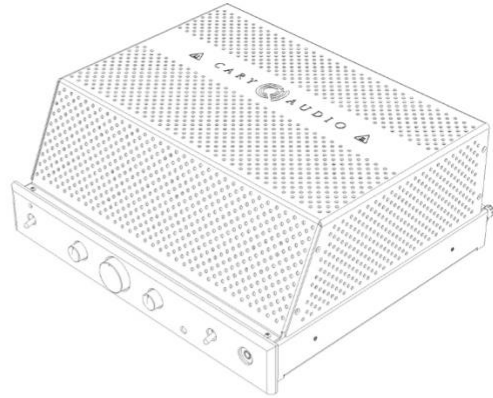

fig 1.1



fig 1.2

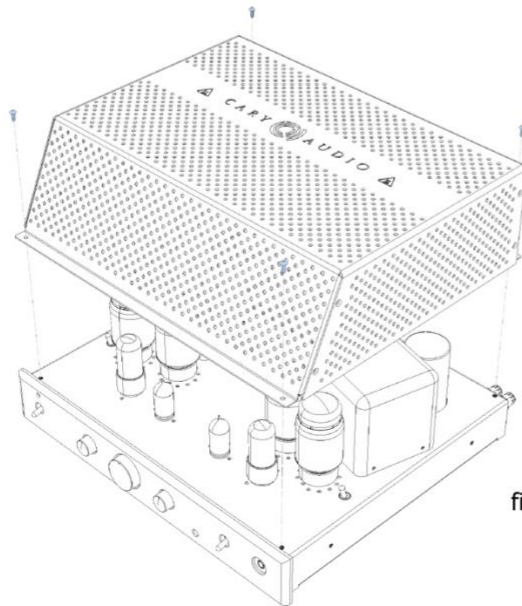

fig1.3

### Caution:



Unit can be hot. Be careful of burned fingers when handling parts. Wait one half hour after switching off to handle parts.

# DIAGRAMS

---

## Bias Adjustment

Set bias for both sides of the amplifier to 75-85mA.

- Insert meter plug into bias jack.
- Adjust for 75-85mA reading on DC current meter.
- Re-adjust to 75-85mA after SLI-80HS is warmed up for 15 minutes.
- Remove plug and enjoy the music!

**Note:** Bias is factory preset; Bias should be reset when installing replacement KT88 tubes.

### Bias Meter Jack

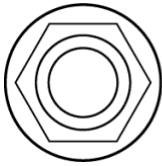

### Bias Adjust

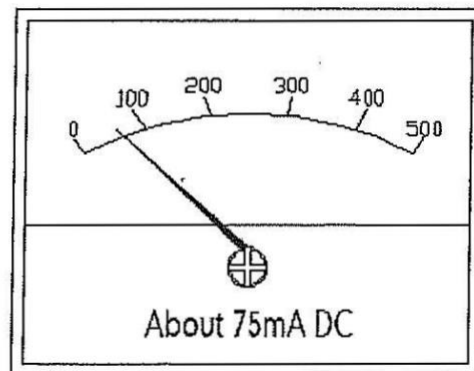
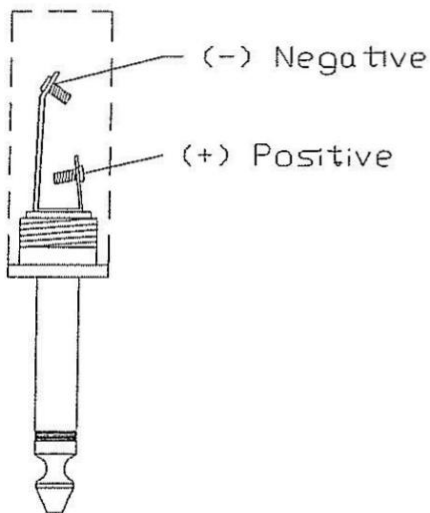
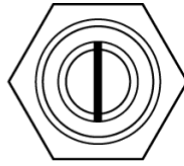

# DIAGRAMS

## Tube Placement Chart

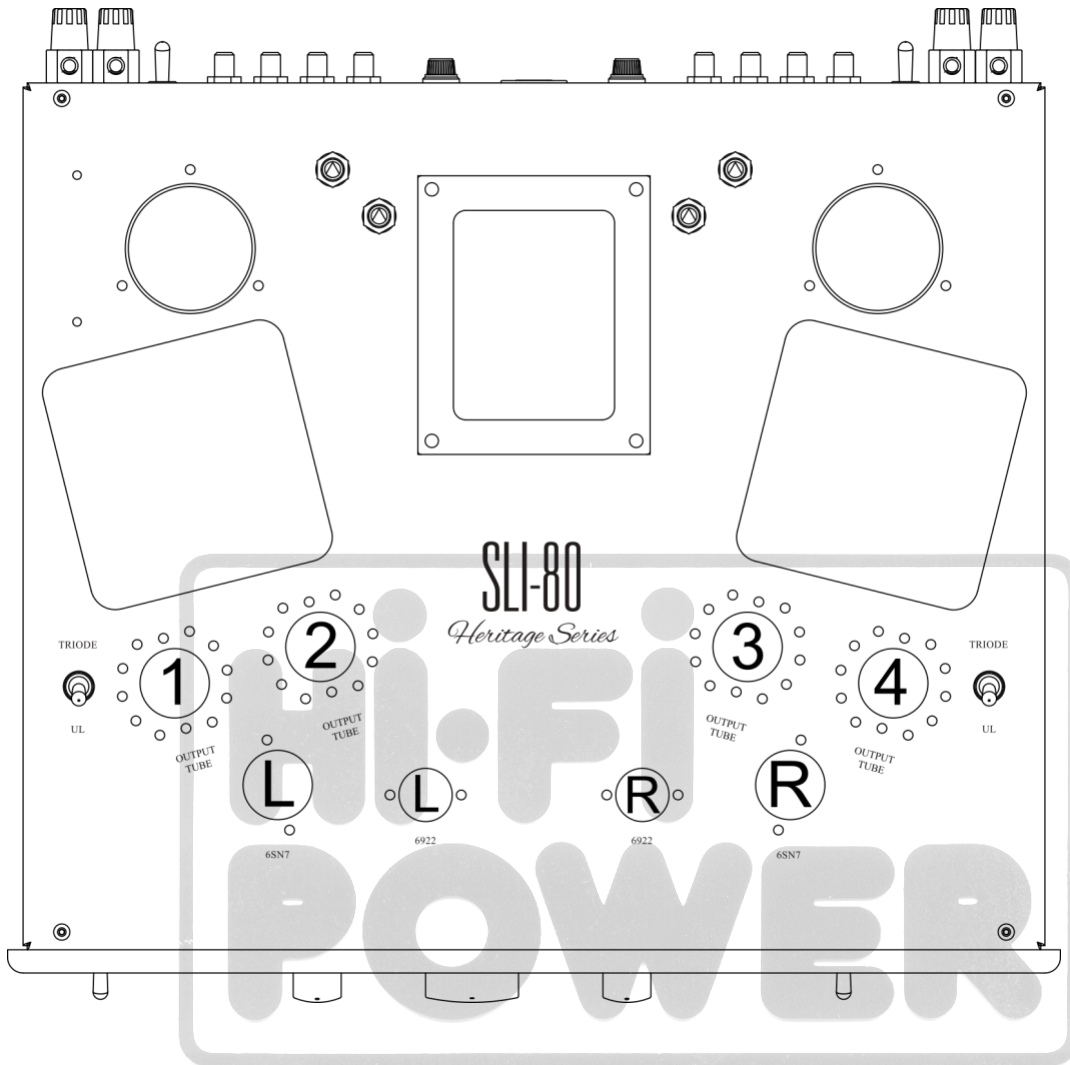

## 4/8 OHM Switch Settings

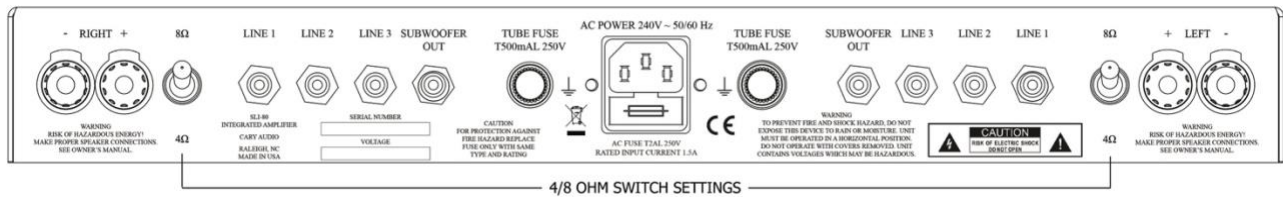

## Rear of Amplifier

# DIAGRAMS

## Side Panel Installation

### Side Panel Installation

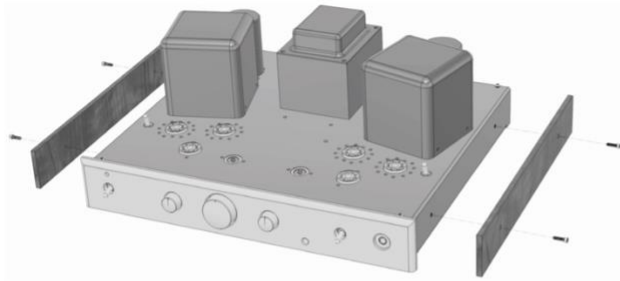
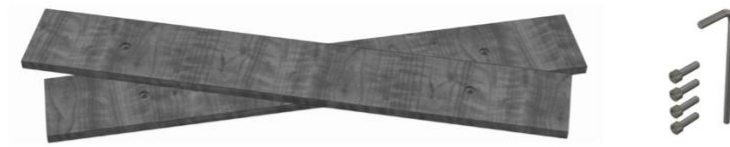

1. Locate and align the screw holes on the side of the SLI-80 chassis with the counterbore holes on the side panels

2. Insert the provided socket cap screws and hand tighten to hold the side panels in place.

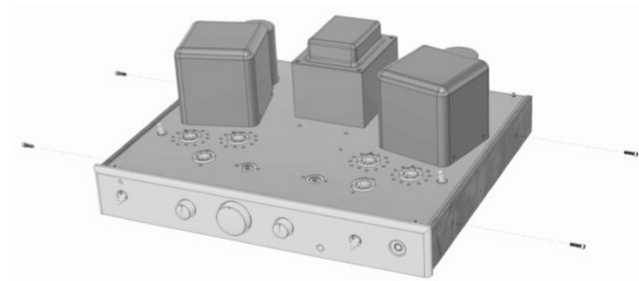

3. Using the provided allen wrench, tighten all (4) screws until the side panels are securely fastened to the chassis.

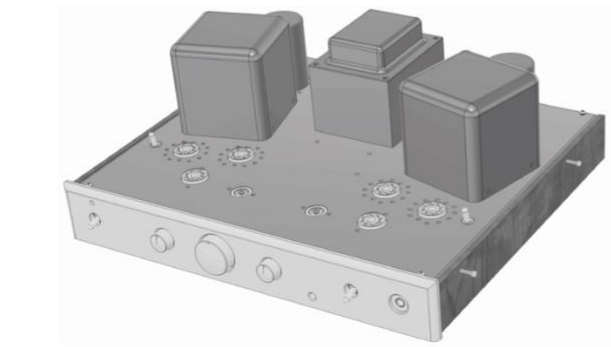

## Remote Control

See Remote Control insert included in original box.

## **SAFETY REQUIREMENTS FOR SERVICING**

---

In order to provide safety protection for the amplifier itself as well as any future service related issues, the following replacement parts should be purchased in their original packaging and direct from the factory. It is not recommended to use any replacement parts other than the original brand.

1. CT-9077 Power Transformer
2. CT-453 Output Transformer
3. T500mAL 250v fuse
4. T2AL 250v fuse

**NOTE:** Replacement parts or service should only be performed by a skilled technician or authorized dealer.

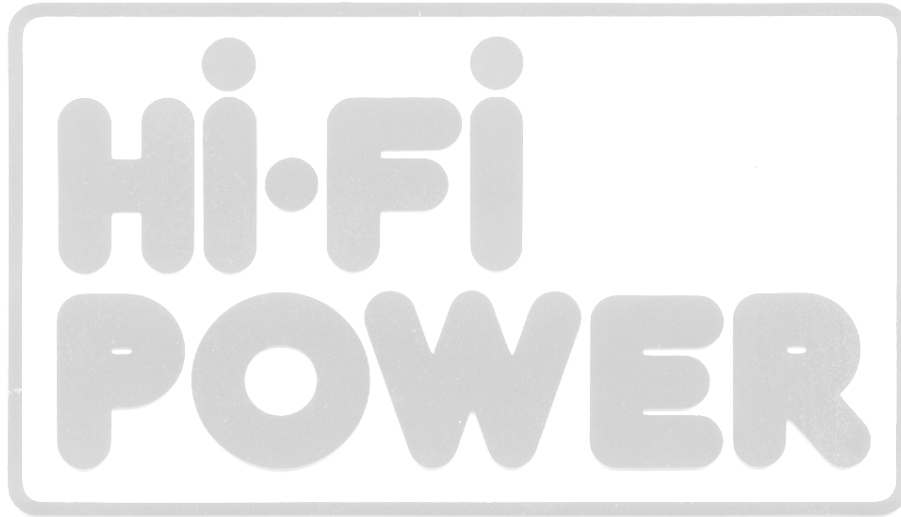



# LIMITED WARRANTY

---

This warranty has been included with a Cary Audio product that is intended to be sold and used only within the United States and Canada. Accordingly, this Warranty only applies to Products which are purchased in the United States or Canada, and only applies while such products are used in the United States or Canada. Products purchased outside the United States or Canada, and failures occurring outside the United States or Canada, are not covered by this Warranty.

## **Cary Audio Warrants to the Original United States and Canada Purchaser for use in the United States or Canada the Following Cary Audio Products for the Periods Indicated:**

1. Power Amplifiers, Integrated Amplifiers, Surround Sound Processors, and Preamplifiers have a three (3) year parts and labor warranty from the date of the original purchase from Cary Audio.
2. CD or SACD players, DVD players, Music Servers, or Digital Music Centers have an eighteen (18) month parts and labor warranty from the date of the original purchase from Cary Audio.
3. Vacuum tubes, if any are used in the component, are offered a 90-day exchange policy against defects with the exception of the 300B vacuum tube that has a one (1) year exchange policy from the date of the original purchase from Cary Audio.

## **Limitations on Non-Cary Audio Provided Services**

Certain Cary Audio Products are designed to employ non-Cary Audio provided services (such as, by way of example only, Spotify, Tidal, etc.), some of which require separate customer subscriptions and some of which do not, as part of the Products' functionality. Because Cary Audio cannot control the providers of such services or the services themselves, the owner of the Product therefore assumes all risks related to the use of services provided by anyone other than Cary Audio itself. Cary Audio cannot and does not warrant against, and shall have no liability of any kind for any of the following that are attributable to non-Cary Audio providers or services: (1) interruption, discontinuance, or other unsatisfactory performance of service, (2) reduced Product functionality that is so attributable, or (3) any other loss or damage of any kind that is so attributable.

## **What is Covered and What is Not Covered**

Except as specified below, this warranty covers parts and labor to correct all defects in materials and workmanship. The following are not covered by the warranty:

1. Damage, deterioration, malfunction or failure to meet performance specifications resulting from:
  - a. Accident, acts of nature, misuse, abuse, neglect or unauthorized product modifications
  - b. Improper installation, removal or maintenance, or failure to follow instructions supplied with the product.
  - c. Repair or attempted repair by anyone not authorized by Cary Audio to repair the product.
  - d. Any shipment of the product (claims must be presented to the carrier).
  - e. Any cause other than a product defect.
2. Cleaning, initial set-up, check-ups with no defects found, or charges incurred for installation, removal or reinstallation of the product.
3. Any product, on which the serial number has been defaced, modified or removed.
4. Batteries.

# LIMITED WARRANTY

---

5. Accessories, including but not limited to, batteries, cables, mounting hardware and brackets, cleaning accessories, antenna and detachable power cords.
6. Warranty is void if purchase was made from anyone other than directly from Cary Audio or an authorized Cary Audio dealer.

## Who May Enforce the Warranty?

This warranty extends to products purchased directly from Cary Audio or an authorized Cary Audio dealer. Purchasers should inquire of the dealer regarding the nature and extent of the dealer's warranty, if any.

To obtain such warranty service, the original purchaser must complete and send in the Warranty Registration Card within 15 days of purchase.

## What Will We Pay For?

We will pay for all labor and material expenses for items covered by the warranty. Payment of shipping charges is discussed in the next section of this warranty.

## How Can You Get Service?

In the event that the owner needs to return the unit to Cary Audio for service or repair of a possible defect, he must follow the following steps:

1. Create a new account or login to our Customer Service Center ([www.caryaudio.com](http://www.caryaudio.com)) to obtain a Return Merchandise Authorization (RMA) number. Once the account is set up or you have logged in, click on "Open New RMA" to begin entering the information to create an RMA that is needed to return or exchange a product. You will be given an RMA number, which must appear on the label of the box you ship back.
2. Submit a copy of the original sales receipt. Blank receipts will not validate the limited warranty for service by Cary Audio. The original sales receipt must contain the following information:
  - a. The authorized Cary Audio dealer's name
  - b. The date of purchase
  - c. The unit's sales price
  - d. The buyer's name and address
  - e. Describe in detail the problem.
  - f. Note the unit's model number and serial number.
3. Deliver by either of these methods:
  - a. With all freight and insurance charges prepaid and in its original packing container or equivalent, ship the component to Cary Audio, 6301 Chapel Hill Road, Raleigh, NC 27607.
  - b. Hand-deliver the product to Cary Audio (address noted above) or the nearest authorized service facility.

# LIMITED WARRANTY

---

## Limitation of Implied Warranties

All implied warranties, including warranties of merchantability and fitness for particular purpose, are limited in duration to the length of this warranty.

## Exclusion of Damages

Cary Audio's liability for any defective product is limited to repair or replacement of the product at Cary Audio's option. Cary Audio shall not be liable for damage to other products caused by any defects in Cary Audio products, damages based upon inconvenience or loss of use of the product or any other damages, whether incidental, consequential, or otherwise.

## How State Law Relates to the Warranty

Some states do not allow limitations on how long an implied warranty lasts and/or do not allow the exclusion or limitation of incidental or consequential damages, so the above limitations or exclusions may not apply to you.

This warranty gives you specific legal rights, and you may also have other rights which vary from state to state.

## International Purchasers (Export Markets)

Cary Audio warrants its merchandise to purchasers within the United States and Canada exclusively for use within the United States or Canada. It provides no other warranties, expressed or implied. If you are living outside of the United States and Canada, please consult your local dealer or distributor to determine the details of your local warranty.

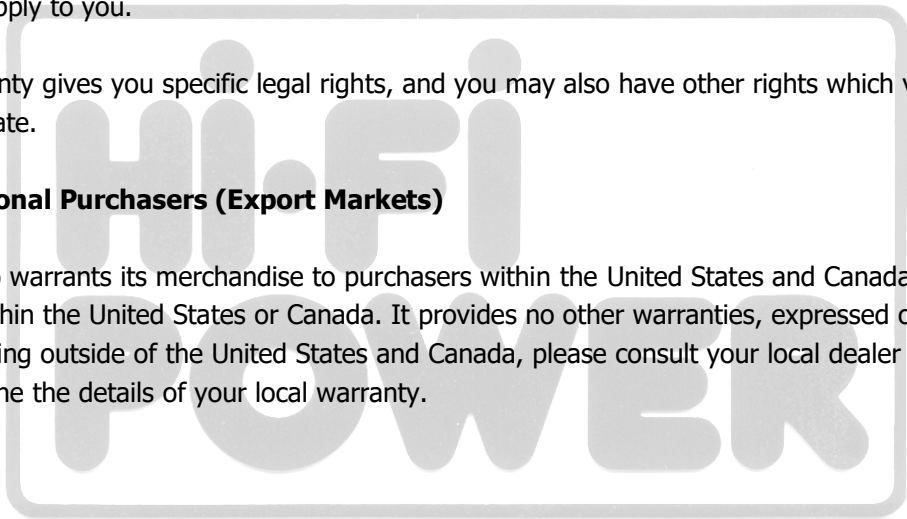

**CARY AUDIO**

6301 Chapel Hill Road  
Raleigh, NC 27607  
919.355.0010  
caryaudio.com  
carydirect.com

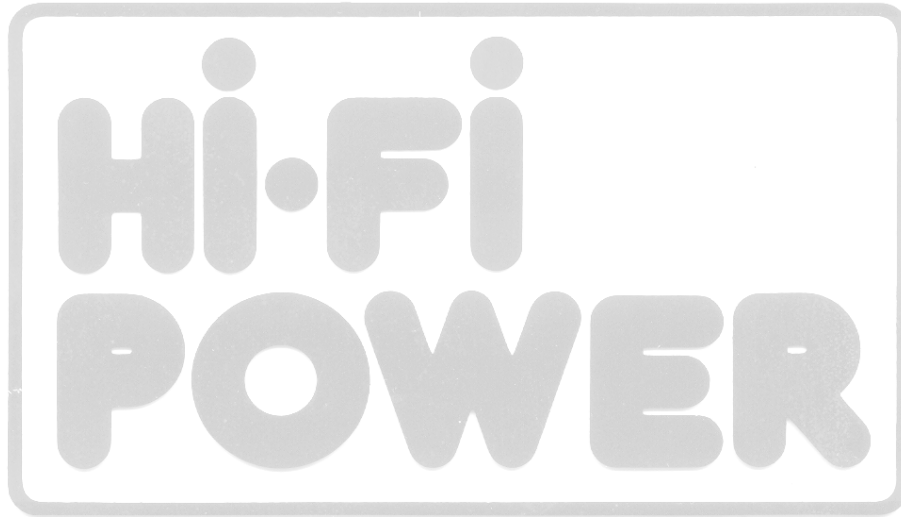

HOME &  
PROFESSIONAL  
AUDIOVISUAL