

# CARY AUDIO

## OWNER'S MANUAL

### **CAD 120S MkII**

Stereo Power Amplifier

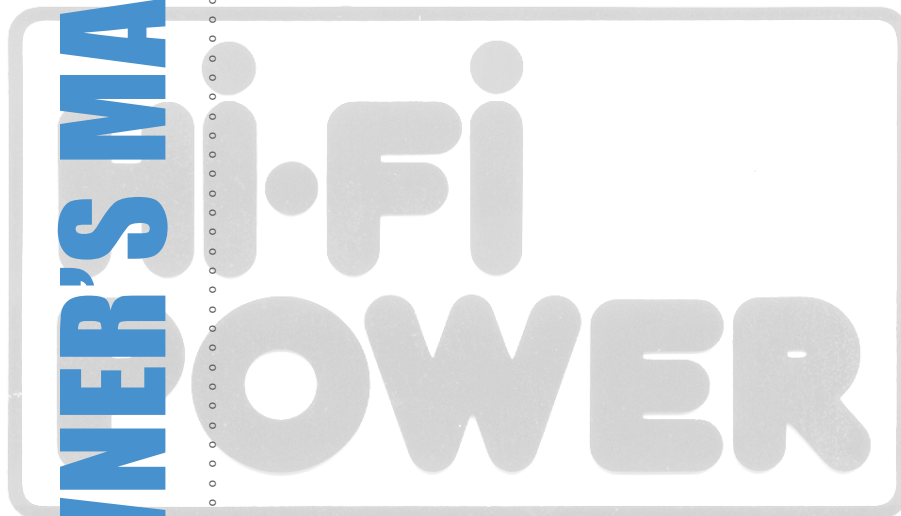

NOTE: Before installing your new component, please read this manual carefully as it will inform you of the product specifications, proper installation and correct operating procedures for your unit. Also included in this manual are guidelines on how to service and care for your new Cary Audio Design product.

# TABLE OF CONTENTS

---

<b>Important Safety Instructions</b> .....	2
<b>Welcome</b>	
Thank You .....	5
Product Features .....	6
Unpacking and Installation .....	7
<b>Specifications</b> .....	8
<b>Controls and Displays</b>	
Front Panel .....	9
Top Panel.....	9
Rear Panel .....	10
<b>Operation</b>	
Speaker Binding Posts.....	11
Triode or Ultra-Linear Mode Switch.....	11
Power ON/OFF Switch.....	11
Bias Measurement and Adjustment.....	11
Break-In Period .....	12
Tube Replacement.....	12
<b>Service and Care</b>	
Care and Cleaning .....	13
Factory Service.....	13
Non-Warranty Repairs.....	13
<b>Limited Warranty</b> .....	14

# IMPORTANT SAFETY INSTRUCTIONS

---

**WARNING:** To reduce the risk of fire or electric shock, do not expose this appliance to rain or moisture. The lightning flash with arrowhead symbol within an equilateral triangle is intended to alert the user to the presence of un-insulated dangerous voltage within the product's enclosure that may be of sufficient magnitude to constitute a risk of electric shock to persons.



**CAUTION:** To reduce the risk of electric shock, do not remove the cover. There are no user serviceable parts inside. Please refer to qualified personnel for service.

**ALERT:** The exclamation point within an equilateral triangle is intended to alert the user of the presence of important operating and maintenance (servicing) instructions in the literature accompanying the component.

1. **READ ALL INSTRUCTIONS:** All the safety and operating instructions of your Cary Audio equipment should be read before power is applied to the equipment.
2. **RETAIN OWNER'S MANUAL:** These safety and operating instructions should be retained for future reference.
3. **HEED WARNING:** All warnings on the unit and in the operating instructions should be adhered to.
4. **FOLLOW INSTRUCTIONS:** All operating and use instructions should be followed.
5. **CLEANING:** Unplug the unit from the wall outlet before cleaning. The unit should be cleaned only as recommended by the manufacturer.
6. **ATTACHMENTS:** Do not use attachments not recommended by the unit manufacturer as they may cause hazards.
7. **WATER AND MOISTURE:** Do not use the unit near water - for example, near a bath tub, wash bowl, kitchen sink, or laundry tub; in a wet basement; or near a swimming pool.
8. **ACCESSORIES:** Do not place the unit on an unstable cart, stand, tripod, bracket, or table. The unit may fall, causing serious injury to a child, an adult, or damage to the unit. Mounting of the unit should follow the manufacturer's instructions and should use a mounting accessory recommended by the manufacturer.
9. **VENTILATION:** Slots and openings in the cabinet are provided for ventilation to ensure reliable operation of the unit and to protect it from overheating. These openings must not be blocked or covered. The top or bottom panel openings should never be blocked by placing the unit on a bed, sofa, rug, or other similar surface. The unit should not be installed in a built-in location such as a bookcase or rack unless proper ventilation is provided. There should be free space of at least 6 inches (16cm) above the unit and an opening behind the unit.
10. **GROUNDING OR POLARIZATION:** The unit may be equipped with a polarized alternating current line plug (a plug having one blade wider than the other). This plug will fit into the power outlet only one way. This is a safety feature. If you cannot insert the plug fully into the outlet, try reversing the plug. If the plug should fail to fit, contact a licensed electrician to replace your obsolete outlet. Do not defeat the safety purpose of the polarized plug.
11. **POWER SOURCES:** The unit should be operated only from the type of power source indicated on the marking label. If you are not sure of the type of power supplied to your home, consult your unit dealer or local power company.
12. **POWER CORD PROTECTION:** Power supply cords should be routed so that they are unlikely to be walked on or pinched by items placed on or against them. Pay close attention to cords where they enter a plug, or a convenience receptacle, and the point where they exit from the unit.
13. **OUTDOOR ANTENNA GROUNDING:** If an outside antenna or cable system is connected to the unit, be sure the antenna or cable system is grounded so as to provide protection against voltage surges and built-up static charges. Article 810 of the National Electrical Code, NSI/NFPA 70, provides information regarding proper grounding of the mast and supporting structure, grounding of the lead-in wire to an Antenna-discharge unit, size of grounding conductors, location of antenna-discharge unit, connection to grounding electrodes, and requirements for the grounding electrode.

# IMPORTANT SAFETY INSTRUCTIONS

---

14. **LIGHTNING:** For added protection for the unit during a lightning storm, or when it is left unattended and unused for long periods of time, unplug it from the wall outlet and disconnect the antenna or cable system. This will prevent damage to the unit due to lightning and power line surges.
15. **POWER LINES:** An outside antenna system should not be located in the vicinity of overhead power lines or other electric light or power circuits, or where it can fall into such power lines or circuits. When installing an outside antenna system, take extreme care to keep from touching such power lines or circuits as contact with them might be fatal.
16. **OVERLOADING:** Do not overload wall outlets, extension cords, or integral convenience receptacles as this can result in a risk of fire or electric shock.
17. **OBJECT AND LIQUID ENTRY:** Never push objects of any kind into the unit through openings as they may touch dangerous voltage points or short-out parts that could result in a fire or electric shock. Never spill liquid of any kind on the unit.
18. **SERVICING:** Do not attempt to service the unit yourself as opening or removing covers may expose you to dangerous voltage or other hazards. Refer all servicing to qualified service personnel.
19. **REPLACEMENT PARTS:** When replacement parts are required, be sure the service technician has used replacement parts specified by the manufacturer or have the same characteristics as the original part. Unauthorized substitutions may result in fire, electric shock or other hazards.
20. **SAFETY CHECK:** Upon completion of any service or repairs to the unit, ask the service technician to perform safety checks to determine that the unit is in proper operating condition.
21. **WALL OR CEILING MOUNTING:** The unit should be mounted to a wall or ceiling only as recommended by the manufacturer.
22. **HEAT:** The unit should be situated away from heat sources such as radiators, heat registers, stoves, or other units (including amplifiers) that produce heat.
23. **IMPORTANT SAFETY NOTE:** Before connecting a new component to your audio or home theater system it is always good practice to make certain that all components are turned off, and preferably unplugged from their AC power source. Many modern electronics products feature automatic turn-on circuits that may be activated during an installation, causing the potential for damage to electronic components and/or speakers. Such damage is not covered by product warranties and Cary Audio specifically disclaims responsibility for any such damage.

**Power Cord:** The removable power cord that is shipped with the player is specifically designed to be used with this product. Other AC cords may be used, so consult your dealer for advice on AC power cords and high quality wire in your system.

**AC Fuse:** The fuse is located inside the chassis and is not user serviceable. If power does not come on, contact your authorized service representative.



**Wiring:** Cables that run inside of walls should have the appropriate markings to indicate compliance with, and listing by the UL, CSA or other standards required by the UL, CSA, NEC or your local building code. Questions about cables inside of walls should be referred to a qualified custom installer, or a licensed electrician or low-voltage contractor.

**Do Not Open the Cabinet:** There are no user serviceable components inside this product. Opening the cabinet may present a shock hazard, and any modification to the product will void your warranty. If water or any metal object, such as a paper clip, coin, or staple accidentally falls inside the unit, disconnect it from the AC power source immediately and contact Cary Audio for further instructions.

24. **RECORDING COPYRIGHT:** Recording of copyrighted material for other than personal use is illegal without permission of the copyright holder.
25. **NOTE TO CATV SYSTEM INSTALLER:** This reminder is provided to call the CATV system installer's attention to article 820-40 of the NEC, ANSI/NFPA 70, which provides guidelines for proper grounding and, in particular, specifies that the cable ground shall be connected to the grounding system of the building, as close to the point of cable entry as practical.

# IMPORTANT SAFETY INSTRUCTIONS

## 26. FCC INFORMATION FOR USER:

**CAUTION:** ANY changes or modifications not expressly approved by the party responsible for compliance could void the user's authority to operate the equipment.



**NOTE:** This equipment has been tested and found to comply with the limits for a Class B digital device pursuant to Part 15 of the FCC Rules.

These limits are designed to provide reasonable protection against harmful interference in a residential installation. This equipment generates and can radiate radio frequency energy and, if not installed and used in accordance with the instructions, may cause harmful interference to radio communications. However, there is no guarantee that interference will not occur in a particular installation. If this equipment does cause harmful interference to radio or television reception, which can be determined by turning the equipment off and on, the user is encouraged to try to correct the interference by one or more of the following measures:

- Reorient or relocate the receiving antenna.
- Increase the separation between the equipment and receiver.

Connect the equipment into an outlet on a circuit different from where the receiver is connected.

## 27. OUTDOOR ANTENNA INSTALLATION/SAFE ANTENNA AND CABLE CONNECTION:

If an outside antenna or cable system is connected to the equipment, be sure the antenna or cable system is grounded so as to provide protection against built up static charges and voltage surges, Section 810 of the national Electrical Code, ANSI/NFP A70 (in Canada, part 1 of the Canadian Electrical Code) provides information with respect to proper grounding of the mast and supporting structure, grounding of the lead-in wire to an antenna discharge unit, size of grounding conductors, location of antenna discharge unit, connection to grounding electrodes and requirements for the grounding electrode.

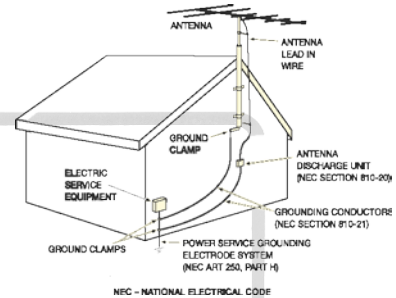

### Keep Antenna Clear of High Voltage Power Lines or Circuits

An outside antenna system should be located well away from power lines, electric light or power circuits and where it will never come into contact with these power sources if it should happen to fall. When installing an outside antenna, extreme care should be taken to avoid touching power lines, circuits or other power sources as this could be fatal. Because of the hazards involved, antenna installation should be left to a professional.

# WELCOME

---

## THANK YOU

Dear Cary Audio Customer:

I am so pleased and excited about the Cary Audio Design CAD 120S stereo vacuum tube power amplifier. I have spent countless hours designing and refining this very special vacuum tube power amplifier. The CAD 120S started life in September of 2006 as a 60 watt ultra-linear push pull amplifier. Billy Wright, my business partner, was concerned that we needed more output power for difficult loudspeaker loads. At this time, I had just completed the new Cary Audio SLP 03 preamplifier as well. Gregg Dunn, our Sales Director came to me in the lab with a suggestion. He suggested that a 120 watt per channel power amplifier made to match the new SLP 03 balanced vacuum tube preamplifier would be a nice combination. I thought this idea had merit and began percolating the design in my head.

In November of 2006, three months after the initial prototype, I had the cosmetic package complete. I needed to have this new baby on display at the January 2007 CES Show. During the CES Show it became evident we had a winner of a product. Countless people wanted to listen to the CAD 120S. The only problem was there was nothing inside. All the circuitry was in my head! My only response to the question of "How does it sound?" was "You're going to love it!"

I am once again an excited "design-boy" proudly displaying the CAD 120S, which went into full production in May 2007 at our "toy" shop in Apex, North Carolina. I can now answer the question: "How does it sound?" "Amazing, I love it, I love it!!!!!!"

Enjoy the music in your home with your CAD 120S and thank you for your support.

God Bless you and your family.

-The Cary Audio Team

### WARNING

- **Electrical hazard! Misuse or failure to follow instructions properly may result in personal injury or death!**

### CAUTION

- **No risk or personal injury; however, misuse or failure to follow instructions may result in damage to equipment.**

### NOTE

- **No risk of personal injury or equipment damage; however, misuse or failure to follow instructions may prevent proper performance of the equipment.**

# WELCOME

---

## PRODUCT FEATURES

The stereo vacuum tube power amplifier has a great history at Cary Audio Design. The previous generation Rocket 88 R and the V 12R power amplifiers garnered fantastic reviews for stable power output, incredible value for the money and sound quality along with 'Best Buy' and 'Class A' ratings from magazines and reviewers worldwide. Building on this storied legacy, we are releasing the CAD 120S stereo vacuum tube power amplifier. This innovative stereo power amplifier is rated at 60 watts per channel in triode mode and 120 watts per channel in ultra linear mode into an 8 ohm speaker load.

Full rated output power is from 17 Hz to 23 kHz with less than 1% total harmonic distortion. The output stage may be switched 'on the fly' from triode mode to ultra linear mode by using a front panel selector button. There are LED lights above the mode selection button to show which mode the power amplifier is working in for visual confirmation. Another nice feature is that the amplifier has an operating mode memory. The CAD 120S will remember either the triode or ultra-linear mode selection when the amplifier is turned to the off position.

The vacuum tubes in each channel consist of one (1) 6SN7 for the input gain, one (1) 6SN7 for the driver stage and four (4) KT 88 output power tubes. The circuit is a balanced design with separate RCA and XLR inputs. A soft start turn on circuit is built-in for long life and easy turn on in large systems. The power supply features 1,120 micro farads of capacitance for ample reserves in demanding usages. The output transformers and the power transformer have a single cover painted to match the chassis.

The backlit front panel meters indicate the bias setting for each channel and visually indicate proper operation for the CAD 120S amplifier.

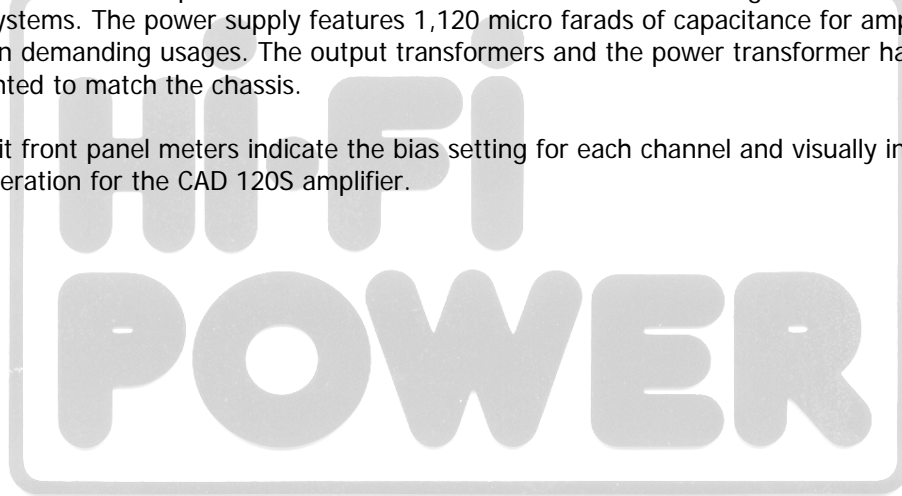



# WELCOME

---

## UNPACKING AND INSTALLATION

This section describes the unpacking and installation procedures for your new component.

### Unpacking

All Cary Audio Design shipping cartons have been specially designed to protect their contents and special care has been taken to prevent damage under normal shipping conditions. Mishandling should be evident upon inspection of the shipping container. If shipping damage is found after visual inspection, take care not to destroy the evidence. If necessary, document the damage with photographs and contact the transport carrier immediately.

Carefully remove your new component from its packing carton and examine it closely for signs of shipping damage. We strongly recommend saving all original packing cartons to protect your component from damage should you wish to store it or ship it at a later date.

### In the Box

When unpacking your CAD 120S power amplifier, make sure the following accessories are included. You should find the following items:

- Power Cable
- Owner's Manual
- Warranty Card
- Spare Fuses

### Warranty Card

If you are the original purchaser of this unit and you purchased it in the United States, you should fill out the enclosed warranty registration card and return it to Cary Audio Design within 15 days of your purchase. Cary Audio Design also suggests that you keep your original packing cartons in case you ever need to ship the unit when moving to a new home. Warranty restrictions apply. Consult the warranty section of this manual for details. Please be certain to keep a copy of the original sales receipt from your Authorized Cary Audio Design dealer to validate the warranty if ever needed.



# SPECIFICATIONS

---

Operating the CAD 120S is a simple procedure. It is designed for long term stability in virtually any home operating environment. However, if the unit is operated outside the parameters outlined in this owner's manual, damage may result. Please read this manual carefully before putting your new CAD 120S amplifier into operation.

The following section describes the CAD 120S amplifiers' basic specifications. The specifications are subject to change without notice or obligation.

<b>Circuit Type</b>	Class AB, push-pull amplifier, Ultra linear or Triode mode operation with a front panel selector switch
<b>Power Output</b>	Ultra linear - 120 watts per channel Triode - 60 watts per channel
<b>Inputs</b>	XLR balanced or RCA single-ended
<b>Noise and Hum</b>	-80 dB
<b>Input Impedance</b>	100K both RCA and Balanced
<b>Frequency Response</b>	17 Hz - 25 KHz flat @ 1 watt
<b>Tubes</b>	2 - 6SN7 input gain stage 2 - 6SN7 driver tubes 8 - KT 88 output tubes
<b>Power Transformer</b>	EI High voltage & bias supply EI laminate
<b>Filament Transformer</b>	2 – EI laminate 6.3 VAC @ 12 amp CCS
<b>Output Transformer(s)</b>	Special bifilar wound 150 watt rating unit in each channel
<b>Resistors</b>	1% precision metal film
<b>Capacitors</b>	Kimber Kaps
<b>Power Supply Capacitors</b>	4 x 560 Micro farads
<b>Speaker Posts</b>	Cary gold plated copper, 5-way binding
<b>AC Cord</b>	3 Conductor Shielded, Detachable
<b>AC Power Requirements</b>	117 VAC @ 50/60 Hz 234 VAC @ 50/60 Hz
<b>Warm-Up Time</b>	3 minutes
<b>Break-In Time</b>	100 hours of playing time
<b>Finish</b>	Jaguar Anthracite black with clear coat finish, silver anodized aluminum faceplate standard (black optional)
<b>Weight</b>	65 lbs
<b>Dimensions</b>	8" H x 17" W x 14" D

# CONTROLS AND DISPLAYS

## FRONT PANEL

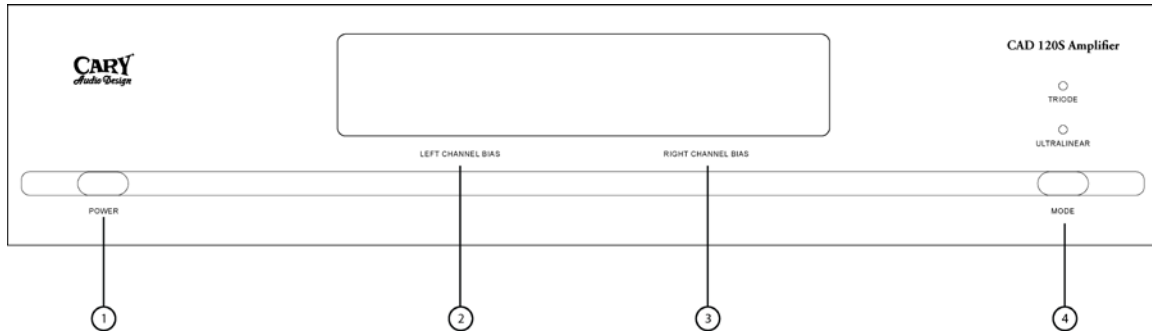

### 1. POWER

- Press once to turn the power ON.
- Press again to turn the power OFF.

### 2. LEFT CHANNEL BIAS

- Indicates a proper DC current of between 130 to 150 ma.

### 3. RIGHT CHANNEL BIAS

- Indicates a proper DC current of between 130 to 150 ma.

### 4. MODE

- Press this button to change between Triode and Ultralinear modes.

## TOP PANEL

The following illustration shows the tube placements on the CAD 120S.

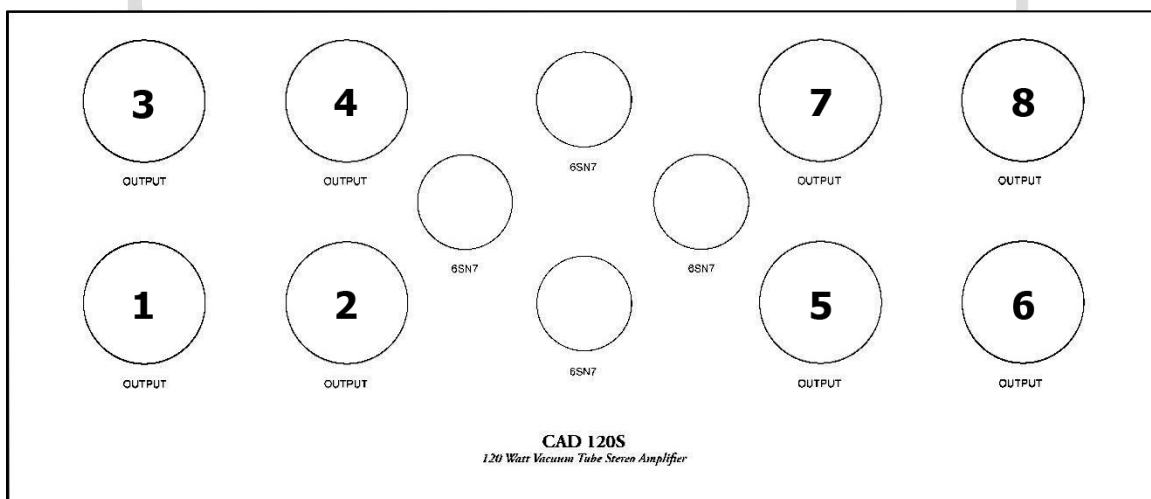

# CONTROLS AND DISPLAYS

## REAR PANEL

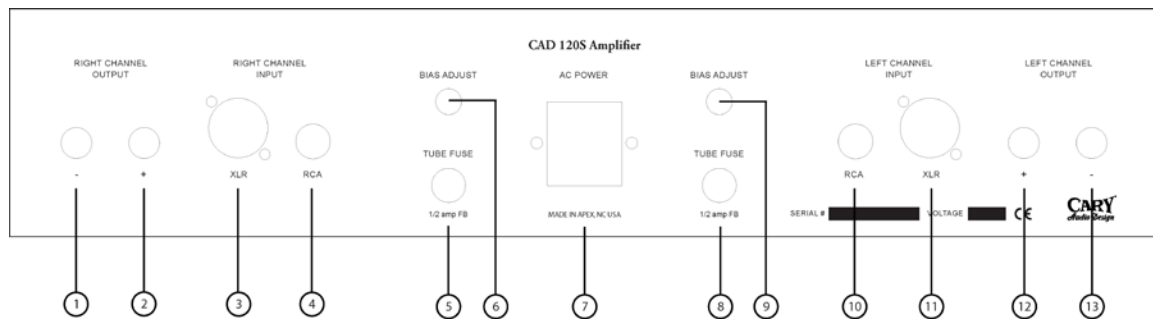

1. RIGHT CHANNEL OUTPUT – NEGATIVE LEAD

2. RIGHT CHANNEL OUTPUT – POSITIVE LEAD

3. RIGHT CHANNEL INPUT – XLR INPUT

4. RIGHT CHANNEL INPUT – RCA INPUT

5. TUBE FUSE ½ AMP FAST BLOW RIGHT CHANNEL

6. BIAS ADJUST POTENTIOMETER RIGHT CHANNEL 130 – 150 ma.

7. AC POWER MAIN FUSE 4 AMP SLOW BLOW

8. TUBE FUSE ½ AMP FAST BLOW LEFT CHANNEL

9. BIAS ADJUSTMENT POTENTIOMETER LEFT CHANNEL 130 – 150 ma.

10. LEFT CHANNEL INPUT – RCA INPUT

11. LEFT CHANNEL INPUT – XLR INPUT

12. LEFT CHANNEL OUTPUT – POSITIVE LEAD

13. LEFT CHANNEL OUTPUT – NEGATIVE LEAD

# OPERATION

---

Your new CAD 120S power amplifier is ready for operation after the speaker, interconnect cables and the vacuum tubes have been installed into their proper sockets. Refer to the labeling on the chassis for placement and proper tube installation.

## SPEAKER BINDING POSTS

The CAD 120S will drive loudspeaker loads from as low as 2 ohms to a high of 16 ohms without any adjustment. Please remember to keep the proper phase on each channel when connecting the loudspeaker cables. Red is positive and black is the negative lead.

## TRIODE OR ULTRA-LINEAR MODE SWITCHES

The push button located on the lower right side of the front panel will toggle from triode to ultra-linear modes. There is a blue LED indicator lamp located above the switch. When this blue LED is illuminated the CAD 120S is in the triode mode. Push the button again and the red LED will appear. The CAD 120S is now in the ultra-linear mode. This mode selector system has a memory feature. The amplifier can be powered down (turned off) and the amplifier operating mode will remain in the last position. The absolute default mode is triode if the amplifier is unplugged from the AC wall outlet.

## POWER ON / OFF SWITCH

The front panel push button located to the lower left is a power on power off selector. With the CAD 120S plugged into the wall AC outlet this button will engage the soft-start system and bring the amplifier to the full operate mode. You will notice that the two DC current meters on the front panel will light up blue. The vacuum tubes will light as well. To power down (turn off) simply push the power button once again and the soft start system will remove the main AC power from the power supply in the CAD 120S.

## BIAS MEASUREMENT

Setting the operating bias levels on the CAD 120S is a rather simple matter thanks to the built in front panel DC current meters. These two meters indicate the DC current being drawn by each channel. The meter to the left reflects the operating current for the left channel. The corresponding meter to the right indicates the operating bias level of the right channel. From the factory the bias has been set to approximately 140 ma. DC current on each channel. This read out will vary with different AC wall voltages.

On the rear panel of the CAD 120S is a bias adjustment potentiometer for each channel. This is a screwdriver slotted shaft control. After the amplifier has been powered up for a few minutes observe the meter readings. The proper reading should be 140 ma. plus or minus 10 ma. To make the bias adjustment insert a flat bladed screwdriver into the rear mounted bias adjustment potentiometer and turn clockwise to raise the bias or counter clockwise to lower the bias reading. There is some interaction between channels. Adjust the right and left channel bias a few times until you have an equal reading (plus or minus a few ma) on each channel. The bias reading level is not critical in respect to a range of a low reading of 125 ma. to a high reading of 170 ma. The preferred reading should be approximately 140 ma. plus or minus 10 ma. The DC bias current value will fluctuate with varying in house AC wall voltage. As air conditioning systems

## OPERATION

---

cycle and power loads in the neighborhood change, the bias reading will fluctuate a bit. This is normal and therefore not critical.

Another word about the meter readings, the louder you play the CAD 120S the more current it will draw. Playing loud, especially in the ultra-linear mode will peg the meters at 200 ma. This is normal and there is a protection circuit built into the metering circuit to prevent damage to the analog meters. Pegging the meters is fun!

### BREAK-IN PERIOD

The tubes, capacitors and output transformers take approximately 100 hours use to settle in for peak performance. The CAD 120S will sound good right out of the box but it will improve within a short time. After the first 50-100 hours you will notice increased depth and tighter bass. This break-in period is true with quality vacuum tube audio amplifiers.

### TUBE REPLACEMENT

If it becomes necessary to replace the tubes in the amplifier, a matched set of output tubes of the same name brand should be used. A new tube kit is available from Cary Audio. You should get years of service from the rugged KT-88 output tubes. The input and driver 6SN7 tubes can last even longer. Other output tubes may be used in the CAD 120S power amplifier; 6L6, 6CA7, KT-66, 6550C, KT-90, KT-99 or EL-34 tubes are all acceptable for use in the output stage of the CAD 120S. Use the same current setting for any of these tubes as described in the bias set up.

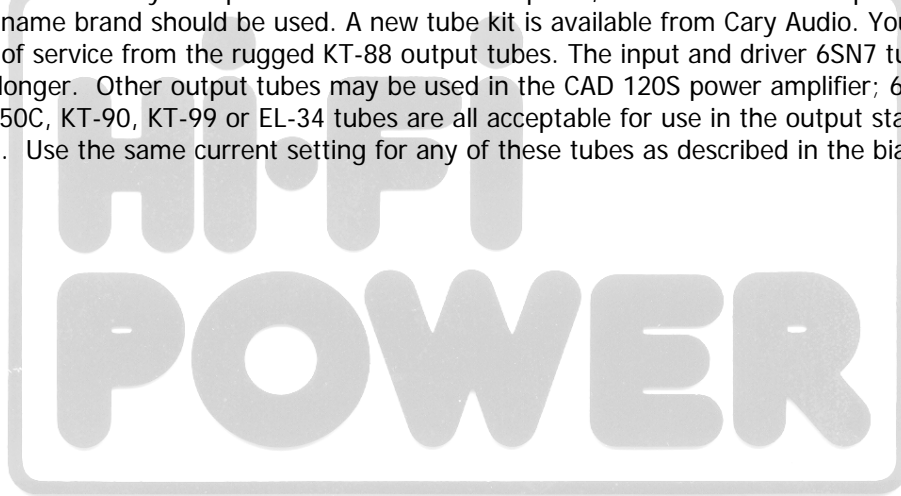

# SERVICE AND CARE

---

## CARE AND CLEANING

The cabinet housing and front panel of the CAD 120S may be cleaned with a soft cloth and Windex or a window cleaner. The frequency of cleaning will be governed by how many hours the CAD 120S is operated and by the cleanliness of the operating environment.

## FACTORY SERVICE

Careful consideration has been given to the design of your CAD 120S to keep maintenance problems to a minimum. Any problems or requests for service should be referred to our Customer Service Department at 919-355-0010. DO NOT return the CAD 120S to the factory without a Return Authorization number (RA) from the Customer Service Department.

Cary Audio Design will assume no responsibility if the shipping company refuses to pay for damage due to your improper packing or lack of insurance should the unit be lost or damaged in shipment. Please retain and always use the original shipping carton for shipping the player.

## NON-WARRANTY REPAIRS

Cary Audio will provide repair service for its products charging on a time and expense basis. At this time, the standard non-warranty service bench fee is \$125 for the first hour and \$95 per hour thereafter. Parts used for repairs as well as return shipping are additional. This may change and is not a quote for service. Please call us at 919-355-0010 for more information about out-of-warranty service and repair fees.

### CAUTION

- **Never remove or insert the back panel AC plug when the unit is on or the AC cord is plugged into the wall.**

# LIMITED WARRANTY

---

**Cary Audio Warrants to the original United States purchaser for use in the United States the Following Cary Audio Products for the Periods Indicated:**

1. Power Amplifiers, Integrated Amplifiers, Surround Sound Processors, and Preamplifiers have a three (3) year parts and labor warranty from the date of the original purchase from Cary Audio.
2. CD or SACD players, DVD players, or Music Servers have an eighteen (18) month parts and labor warranty from the date of the original purchase from Cary Audio.
3. Vacuum tubes, if any are used in the component, are offered a 90-day exchange policy against defects with the exception of the CAVT 300B vacuum tube that has a one (1) year exchange policy from the date of the original purchase from Cary Audio.

## **What is Covered and What is Not Covered**

Except as specified below, this warranty covers parts and labor to correct all defects in materials and workmanship. The following are not covered by the warranty:

1. Damage, deterioration, malfunction or failure to meet performance specifications resulting from:
  - a. Accident, acts of nature, misuse, abuse, neglect or unauthorized product modifications
  - b. Improper installation, removal or maintenance, or failure to follow instructions supplied with the product.
  - c. Repair or attempted repair by anyone not authorized by Cary Audio to repair the product.
  - d. Any shipment of the product (claims must be presented to the carrier).
  - e. Any cause other than a product defect.
2. Cleaning, initial set-up, check-ups with no defects found, or charges incurred for installation, removal or reinstallation of the product.
3. Any product, on which the serial number has been defaced, modified or removed.
4. Batteries.
5. Accessories, including but not limited to, batteries, cables, mounting hardware and brackets, cleaning accessories, antenna and detachable power cords.
6. Warranty is void if purchase was made from anyone other than an authorized Cary Audio dealer.

## **Who May Enforce the Warranty?**

This warranty extends to products purchased directly from Cary Audio or an authorized Cary Audio dealer. Purchasers should inquire of the dealer regarding the nature and extent of the dealer's warranty, if any.

To obtain such warranty service, the original purchaser must complete and send in the Warranty Registration Card within 15 days of purchase.



# LIMITED WARRANTY

---

## What Will We Pay For?

We will pay for all labor and material expenses for items covered by the warranty. Payment of shipping charges is discussed in the next section of this warranty.

## How You Can Get Service?

In the event that the owner needs to return the unit to Cary Audio for service or repair of a possible defect, he must follow the following steps:

1. Contact Cary Audio at 919-355-0010 to obtain a Return Merchandise Authorization (RMA) number prior to shipping; include this number with the package
2. Submit a copy of the original sales receipt; blank receipts will not validate the limited warranty for service by Cary Audio. The original sales receipt must contain the following information:
  - a. The authorized Cary Audio dealer's name
  - b. The date of purchase
  - c. The unit's sales price
  - d. The buyer's name and address
  - e. Describe in detail the problem.
  - f. Note the unit's model number and serial number.
3. Deliver by either of these methods:
  - a. With all freight and insurance charges prepaid and in its original packing container or equivalent, ship the component to Cary Audio, 1020 Goodworth Drive Apex, NC 27539.
  - b. Hand-deliver the product to Cary Audio (address noted above) or the nearest authorized service facility.

## Limitation of Implied Warranties

All implied warranties, including warranties of merchantability and fitness for particular purchase, are limited in duration to the length of this warranty.

## Exclusion of Damages

Cary Audio's liability for any defective product is limited to repair or replacement of the product at Cary Audio's option. Cary Audio shall not be liable for damage to other products caused by any defects in Cary Audio products, damages based upon inconvenience or loss of use of the product, or any other damages, whether incidental, consequential, or otherwise.

# LIMITED WARRANTY

---

## How State Law Relates to the Warranty

Some states do not allow limitations on how long an implied warranty lasts and/or do not allow the exclusion or limitation of incidental or consequential damages, so the above limitations or exclusions may not apply to you.

This warranty gives you specific legal rights, and you may also have other rights which vary from state to state.

## International Purchasers (Export Markets)

Cary Audio warrants its merchandise to purchasers within the United States exclusively for use within the United States. It provides no other warranties, expressed or implied. If you are living outside of the United States, please consult your local dealer or distributor to determine the details of your local warranty.

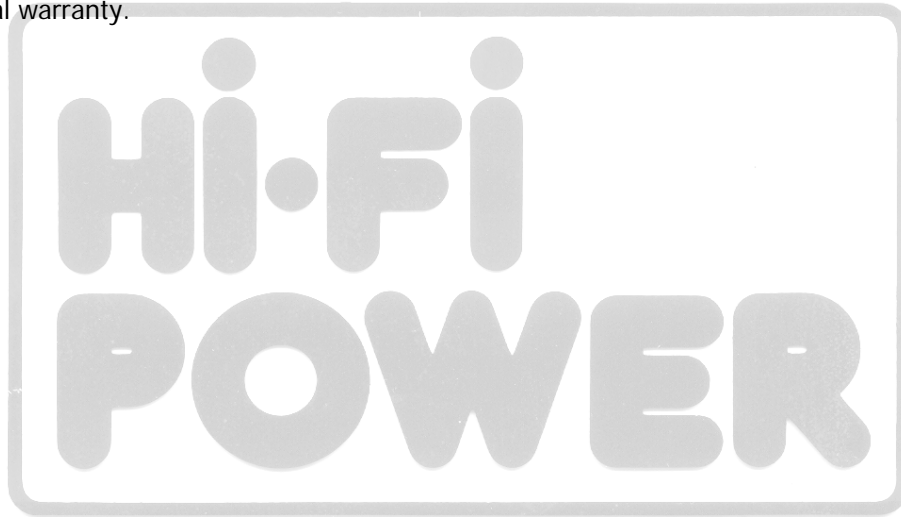

**CARY AUDIO DESIGN**

1020 Goodworth Drive, Apex, NC 27539  
phone 919-355-0010  
fax 919-355-0013  
www.caryaudio.com

